

GRAF EcoBloc Inspect smart/ smart plus

GRAF EcoBloc Inspect smart

Best.-Nr. 402500

GRAF EcoBloc Inspect smart plus

Best.-Nr. 402530



DE:

Die in dieser Anleitung beschriebenen Punkte sind unbedingt zu beachten. Bei Nichtbeachtung erlischt jeglicher Garantieanspruch. Für alle über GRAF bezogenen Zusatzartikel erhalten Sie separate in der Transportverpackung beiliegende Einbauanleitungen. Die Firma GRAF bietet ein umfangreiches Sortiment an Zubehörteilen, die alle aufeinander abgestimmt sind und zu kompletten Systemen ausgebaut werden können. Die Verwendung nicht von GRAF freigegebener Zubehörteile führt zu einem Ausschluss der Gewährleistung/Garantie.

EN:

The points described in these instructions must be observed under all circumstances. All warranty rights are invalidated in the event of non-observance. Separate installation instructions are enclosed in the transportation packaging for all additional articles purchased from GRAF. GRAF offers an extensive range of accessories, all of which are designed to match each other and which can be extended to form complete systems. The use of accessories that have not been approved by GRAF results in the exclusion of the warranty/guarantee.

FR:

Afin de garantir le bon fonctionnement et la longévité de votre installation, les différents points décrits dans cette notice doivent scrupuleusement être respectés. Tout manquement à ces règles annulera systématiquement la garantie. Lisez également toutes les notices des autres éléments fournis par la société GRAF. Vous trouverez les notices de montage jointes dans l'emballage. La société GRAF vous propose une large gamme d'accessoires d'une grande compatibilité. GRAF décline toute prise en charge sous garantie en cas d'utilisation d'accessoires non conformes.

ES:

Los puntos descritos en este manual deben leerse obligatoriamente. La no consideración de los mismos conlleva la extinción de cualquier derecho de garantía. Para todos los artículos adicionales comprados a través de GRAF recibirá un manual de montaje separado incluido en el embalaje de transporte. La compañía GRAF ofrece un amplio surtido de accesorios que han sido adaptados entre sí y que pueden ampliarse para formar sistemas completos. El uso de accesorios no aprobados por GRAF da lugar a la pérdida de la garantía legal/comercial.

1. Allgemeine Hinweise / General product information / Généralités / Indicaciones generales

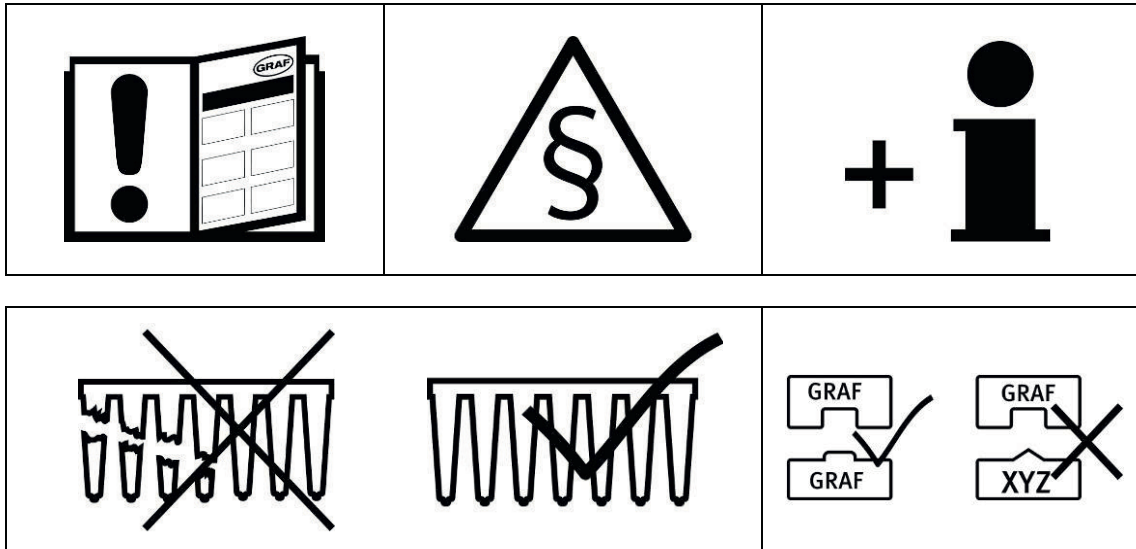



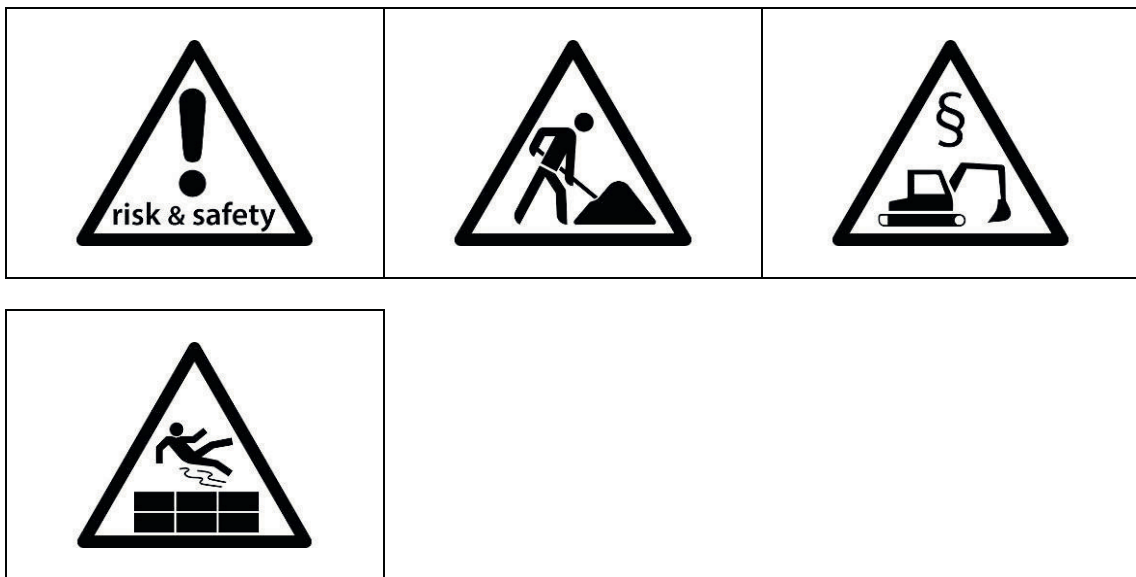

2. Sicherheitshinweise / Safety notes / Remarques de sécurité / Notas de seguridad

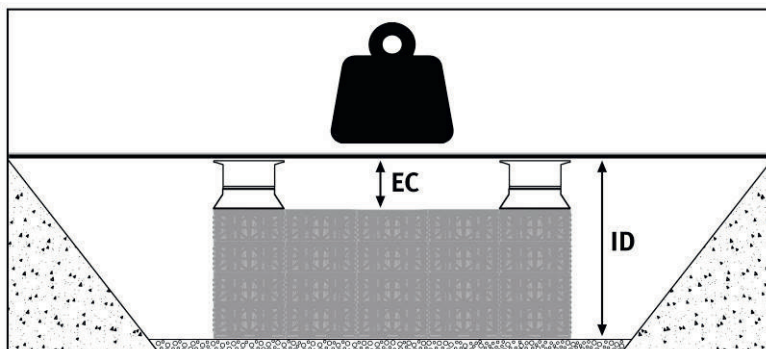

EcoBloc Inspect smart/ smart plus

3. Einbaufenster / installation window / Conditions de pose / Parámetros de instalación



	smart	smart plus
	# 402500	# 402530
 Min. EC	250 mm (9.8")	250 mm (9.8")
 Min. EC	*	*
Max. EC	**	**
ID	5000 mm (16' 4.8")	6000 mm (19' 8.2")
ID	>5000 mm (16' 4.8")**	>6000 mm (19' 8.2")**

* Bitte kontaktieren Sie GRAF für weitere Informationen / Contact your local GRAF partner / Contactez votre partenaire local du GRAF / Contacta tu partner local GRAF

** Die maximal zulässige Erdüberdeckung ist durch einen Statiknachweis oder Rücksprache mit GRAF zu bestimmen / Acceptance limits for maximum earth coverage shall be defined via structural analysis or in consultation with GRAF / Les limites d'acceptation pour la hauteur de remblai maximale sont définies par un calcul des structures ou consultation avec GRAF / Los límites aceptables para la cobertura máxima de tierra se definirán mediante análisis estructural o a través de una consulta con GRAF



www.graf.info



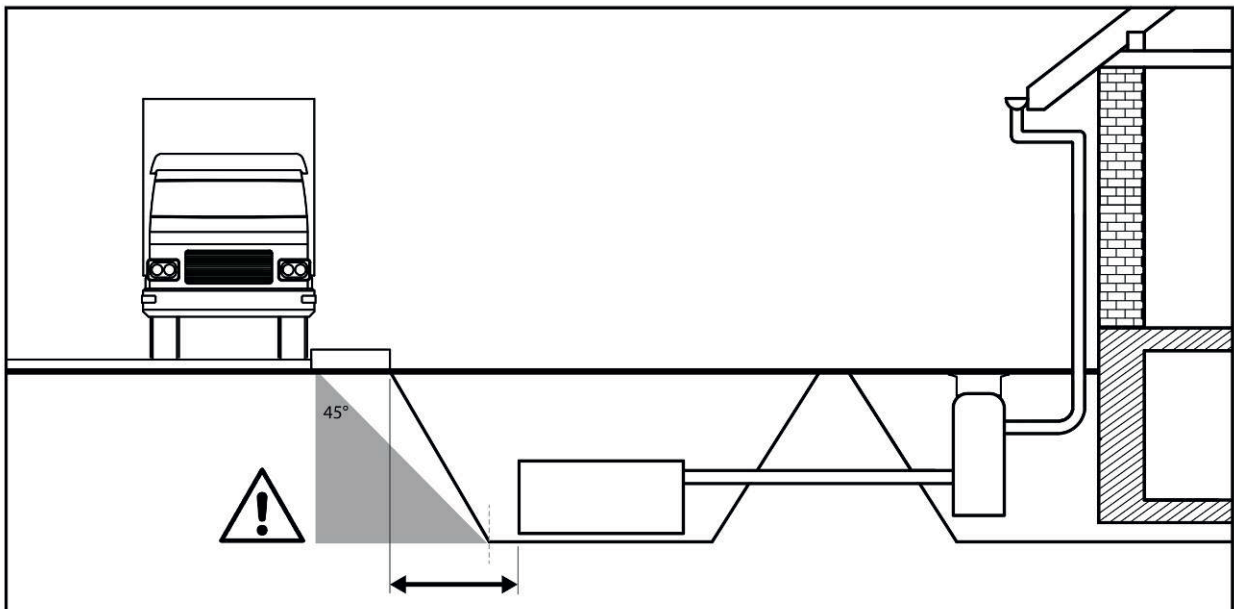
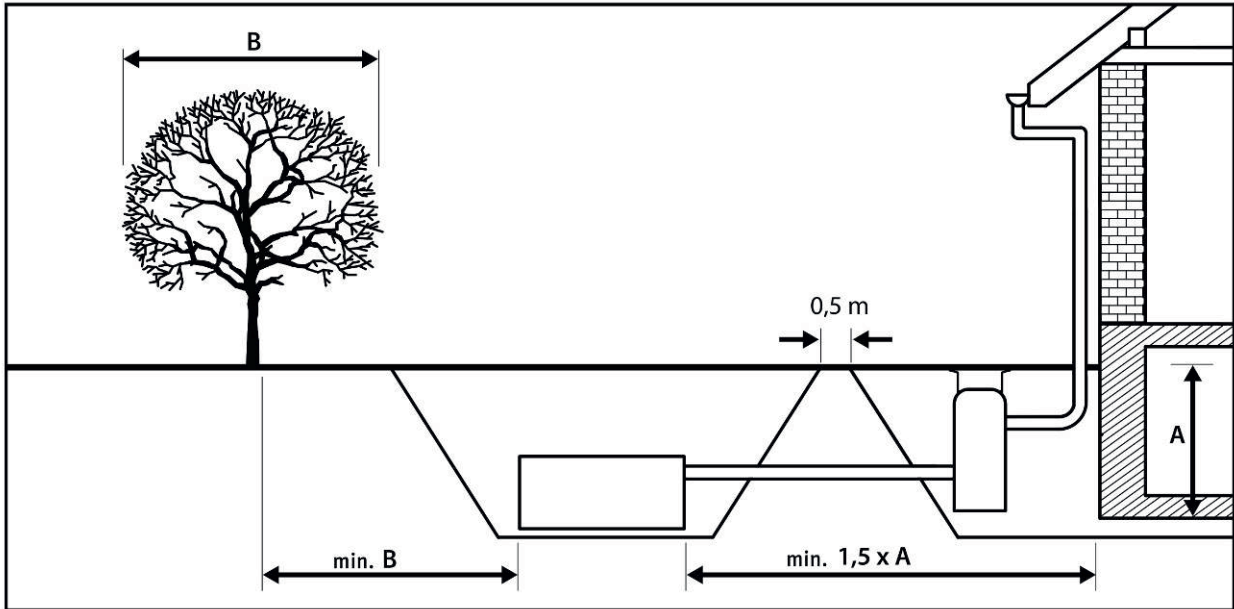



4. Standortwahl / Site of installation / Choix du lieu d'implantation / Lugar de instalación

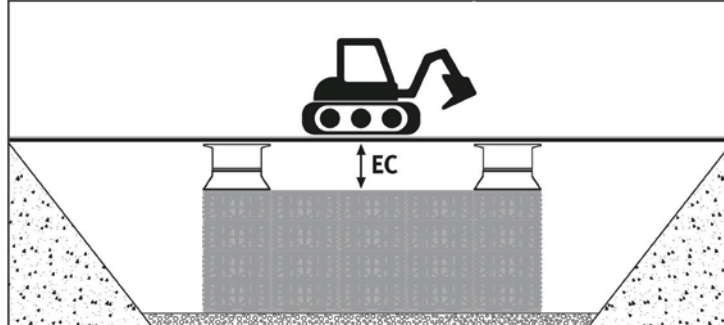

EcoBloc Inspect smart/ smart plus

5. Befahren mit Baumaschinen in der Einbauphase / Use of construction machinery in the installation phase / Passage d'engins de chantier / Circulación con máquinas de construcción



	smart	smart plus
	# 402500	# 402530
 <div style="display: inline-block; vertical-align: middle;"> <p>min. EC</p> <p>approx. 0.7 t (1,543 lbs)</p> </div>	100 mm (3.9")	100 mm (3.9")
 <div style="display: inline-block; vertical-align: middle;"> <p>min. EC</p> <p>approx. 2.5 t (5,512 lbs)</p> </div>	200 mm (7.9")	150 mm (5.9")
 <div style="display: inline-block; vertical-align: middle;"> <p>min. EC</p> <p>approx. 7.5 t (16,535 lbs)</p> </div>	300 mm (11.8")	250 mm (9.8")
 <div style="display: inline-block; vertical-align: middle;"> <p>12 to / H-10, H-15</p> <p>min. EC</p> <p>approx. 12 t (26,456 lbs)</p> </div>	500 mm (1' 7.7")	300 mm (11.8")
 <div style="display: inline-block; vertical-align: middle;"> <p>40 to / HS-20</p> <p>min. EC</p> <p>approx. 40 t (88,185 lbs)</p> </div>	500 mm (1' 7.7")	400 mm (1' 3.8")
 <div style="display: inline-block; vertical-align: middle;"> <p>60 to / HS-25</p> <p>min. EC</p> <p>approx. 60 t (132,275 lbs)</p> </div>	800 mm (2' 7.5")	600 mm (1' 11.6")



Das Befahren mit Verdichtungsgeräten mit eingeschalteten Vibrationsmotoren ist nicht zulässig! / Compression equipment with activated vibration motors must not be taken over the area! / Il est interdit de rouler sur l'ouvrage avec des compacteurs en mode vibration! / No se permite el tránsito con equipos de compactación con motores de vibración conectados!

EcoBloc Inspect smart/ smart plus

6. Werkzeug / Tools / Les outils / Herramientas

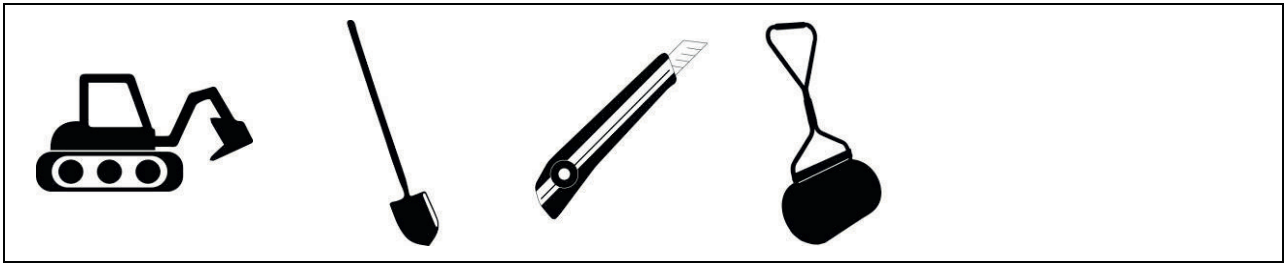

7. Sortiment / Product range / Gamme / Surtido

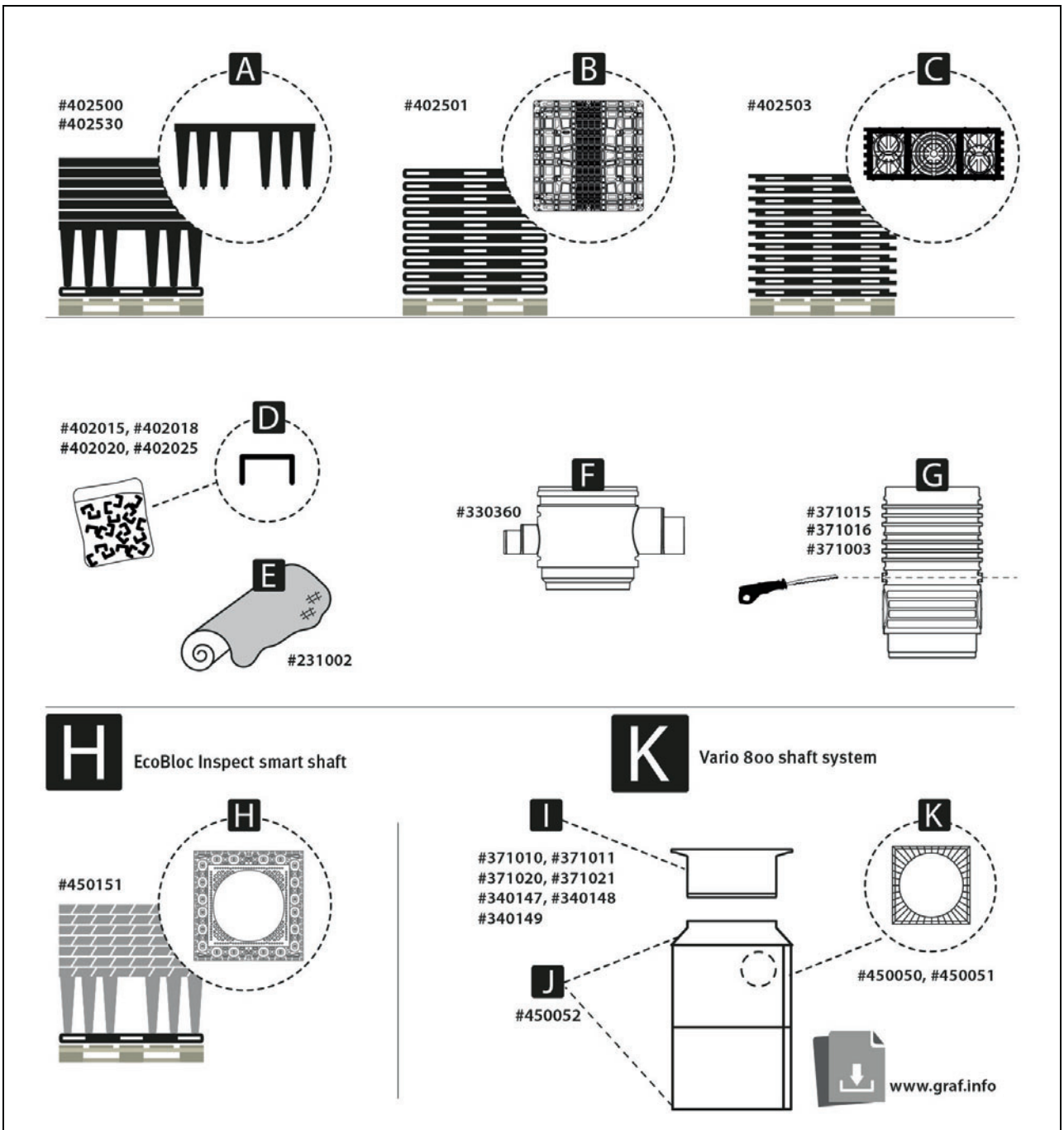

EcoBloc Inspect smart/ smart plus

8. Einbau und Montage / Installation and assembly / Mise en place et montage / Instalación y montaje

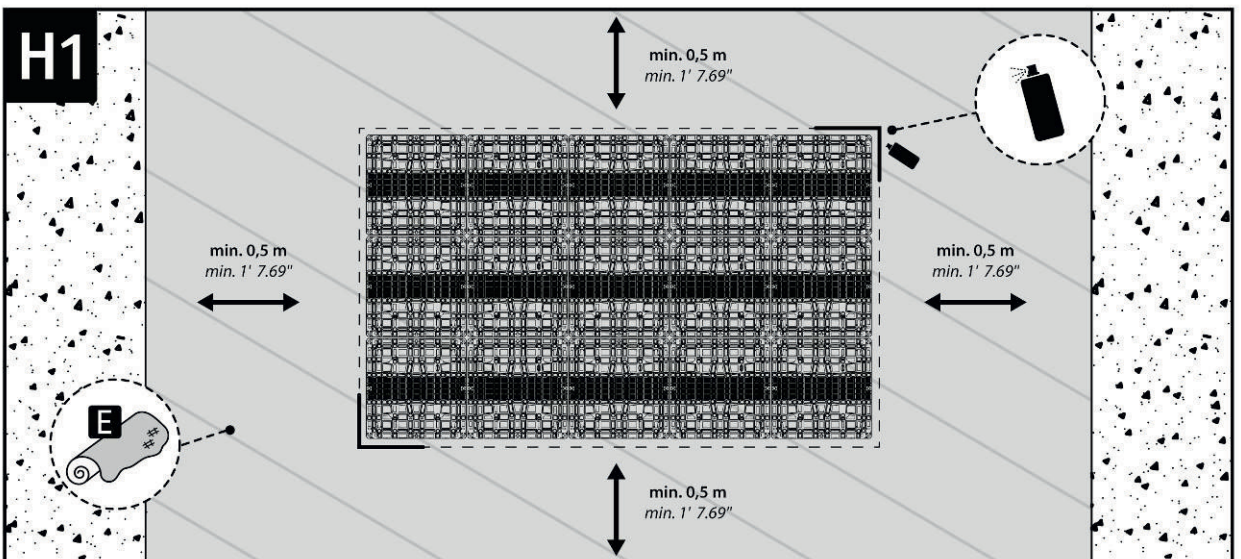
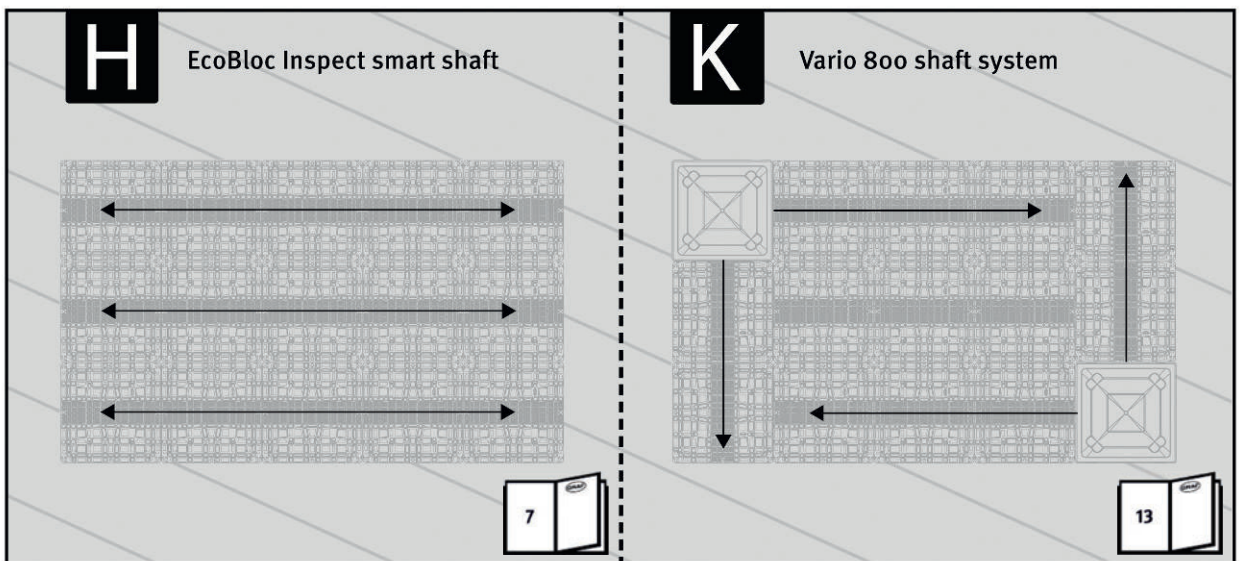
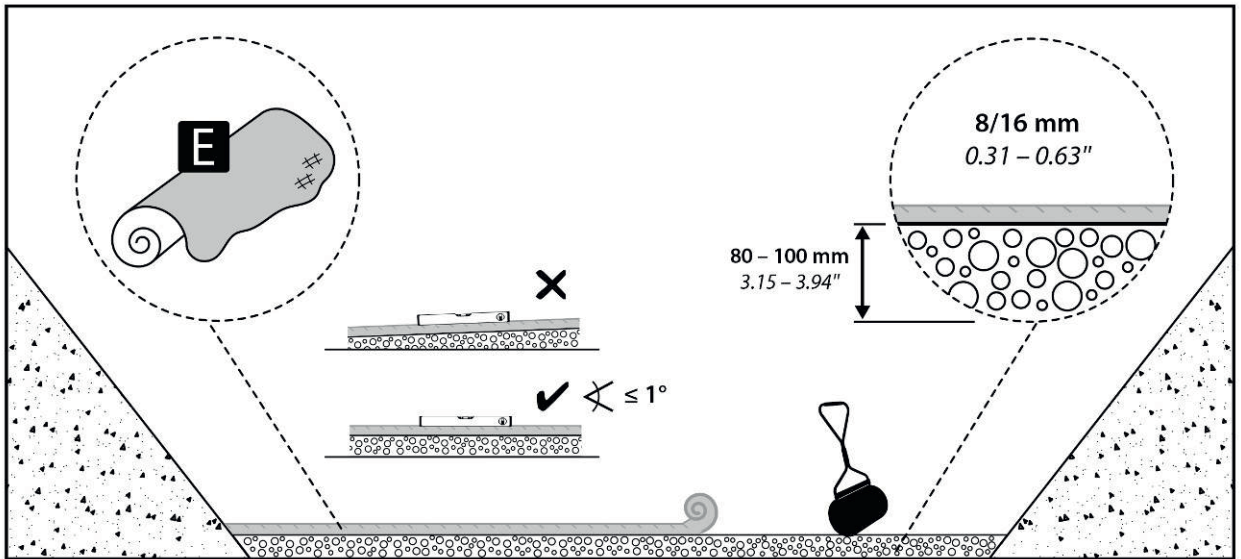

H2

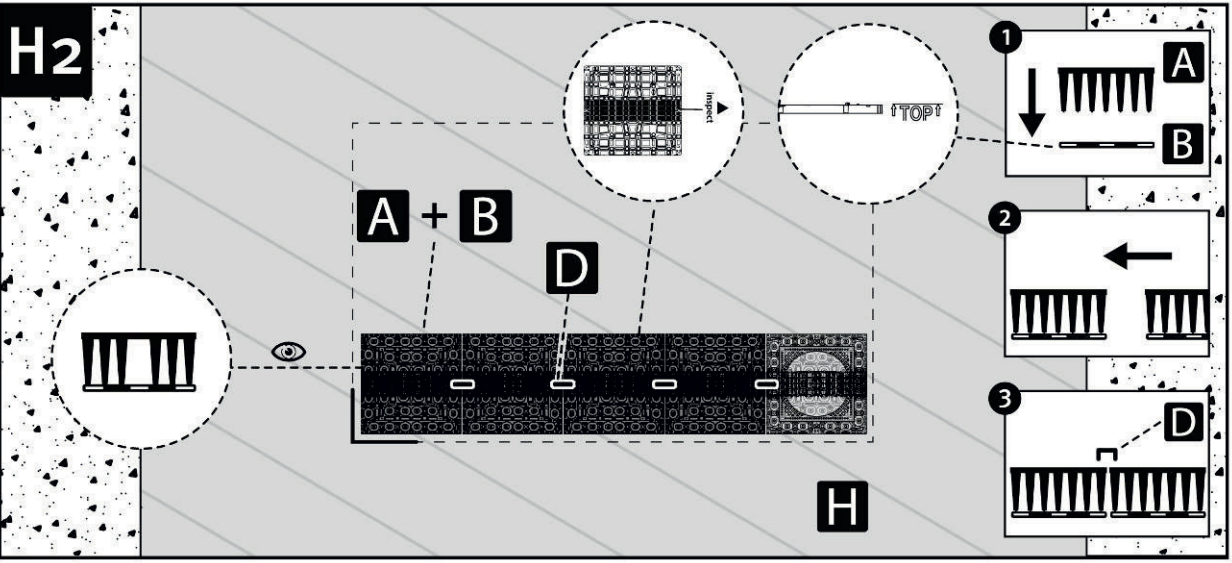

H3

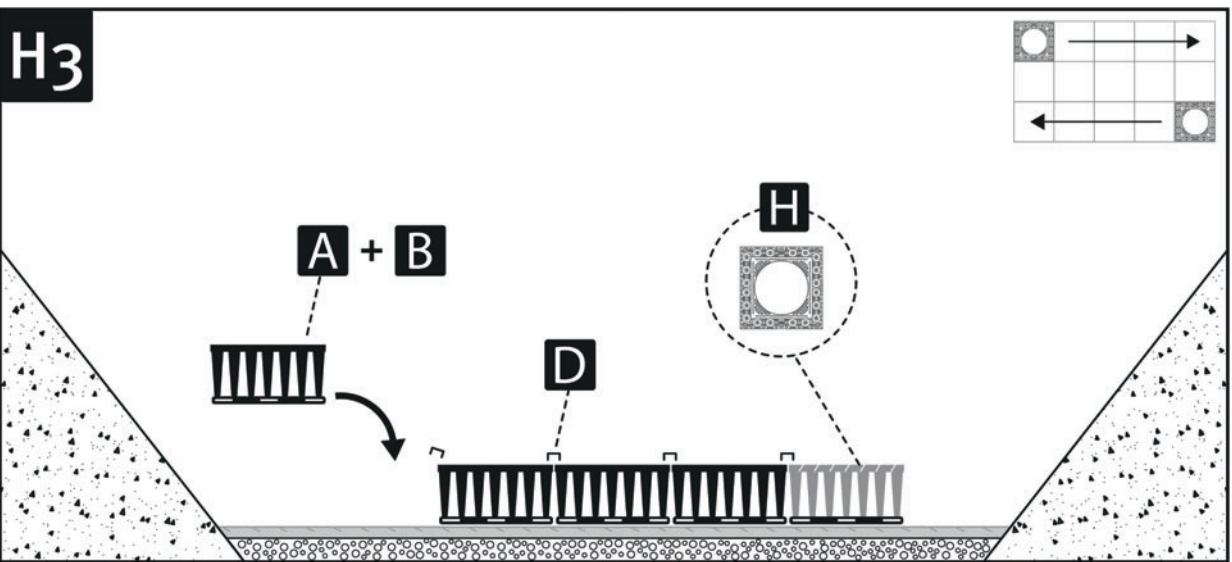

H4

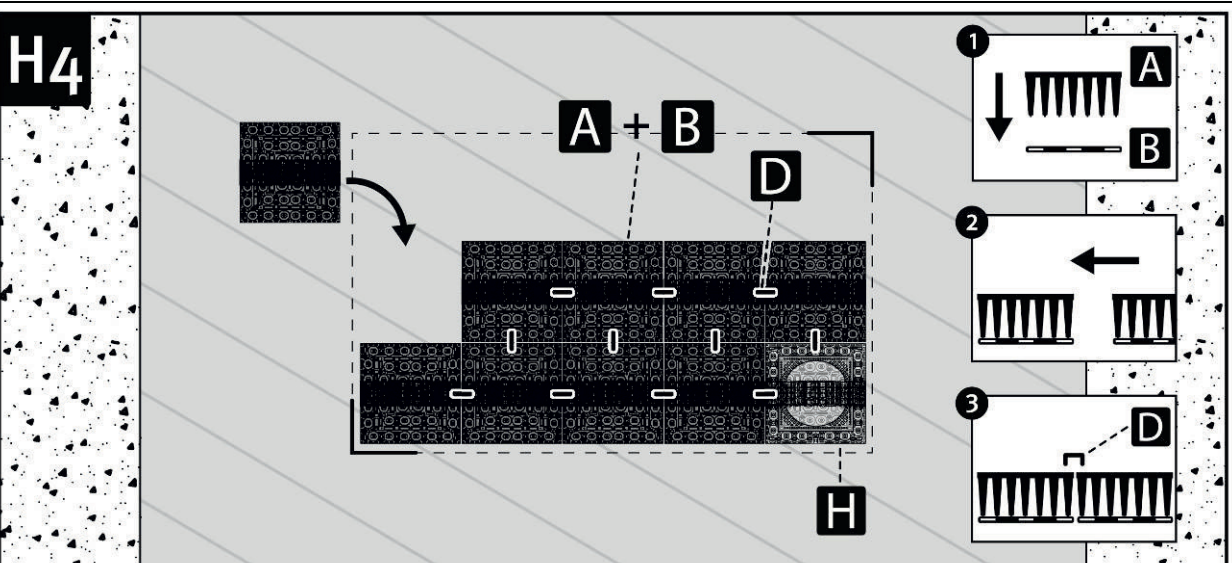

H5

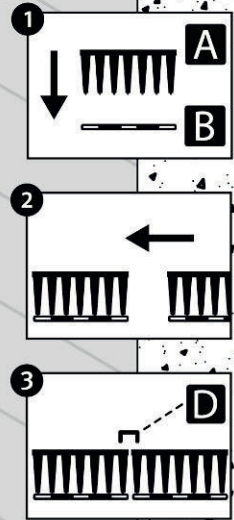
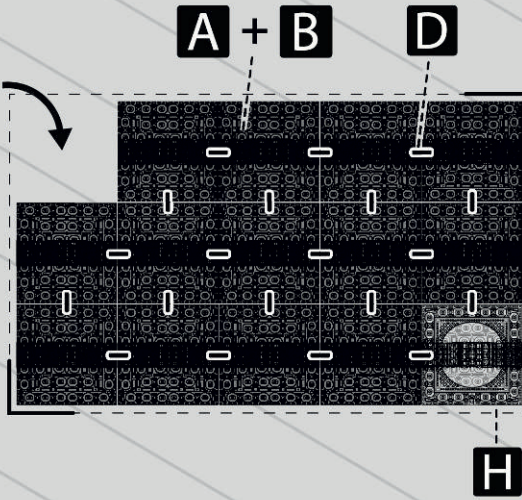
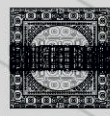

H6

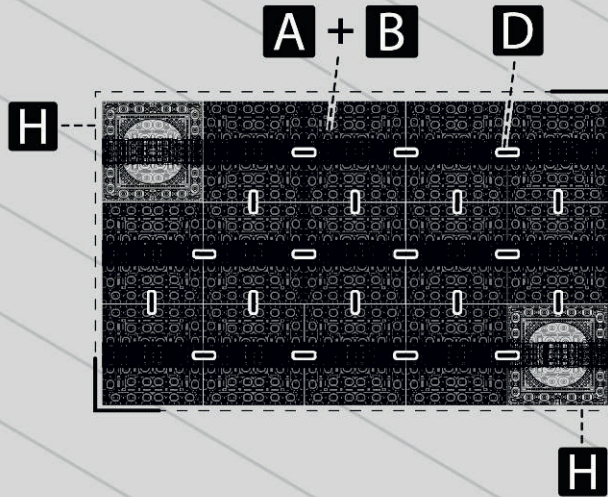

H7

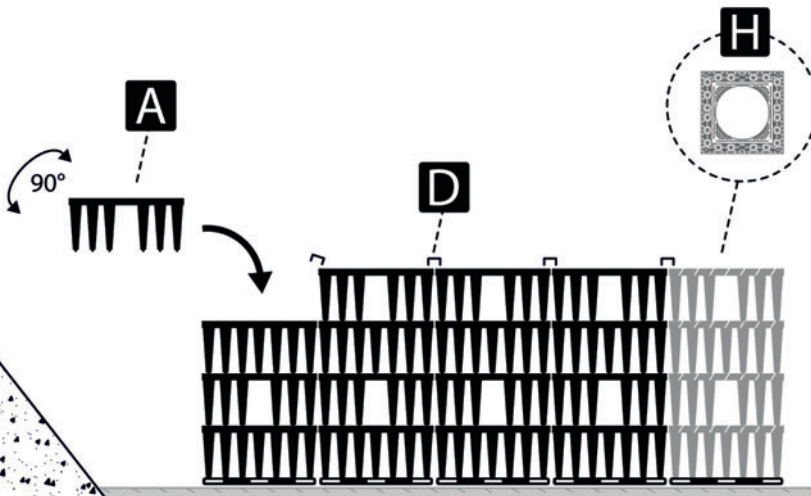

H8

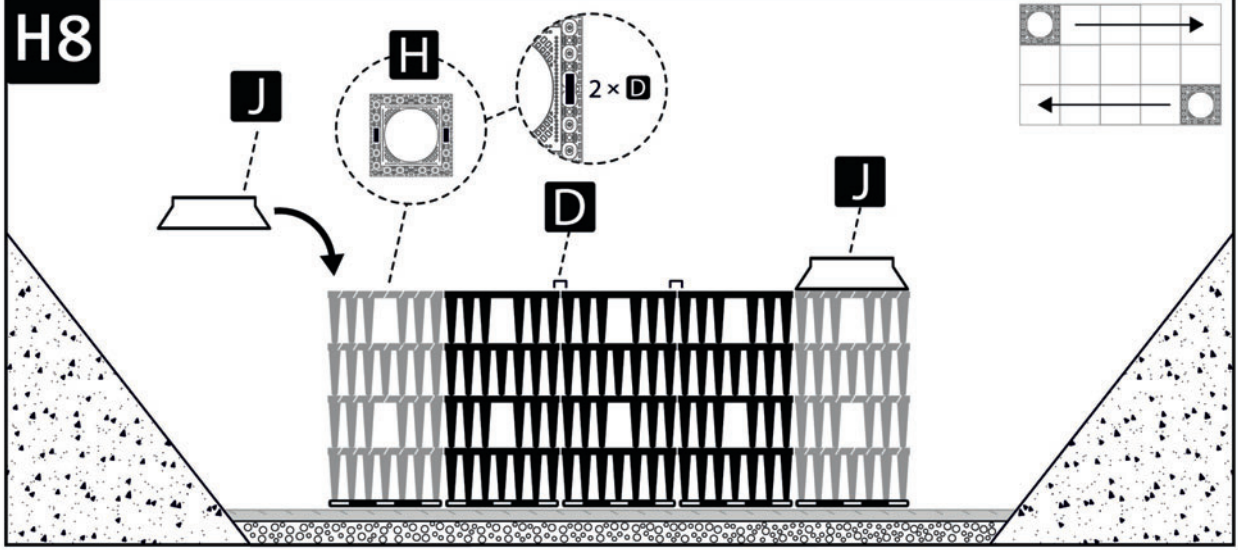

H9

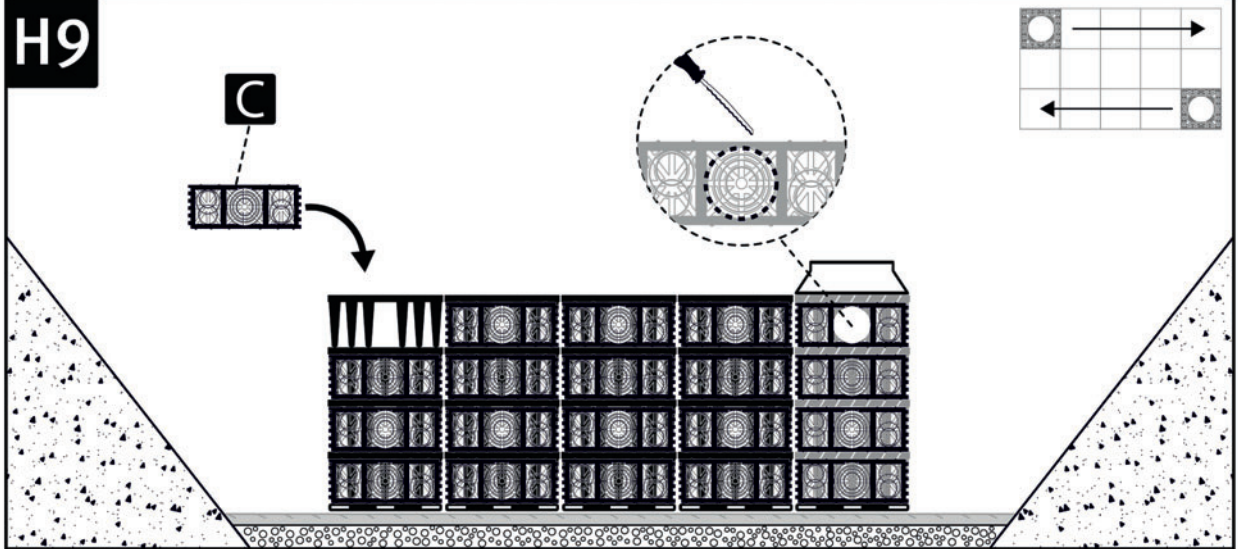

H10

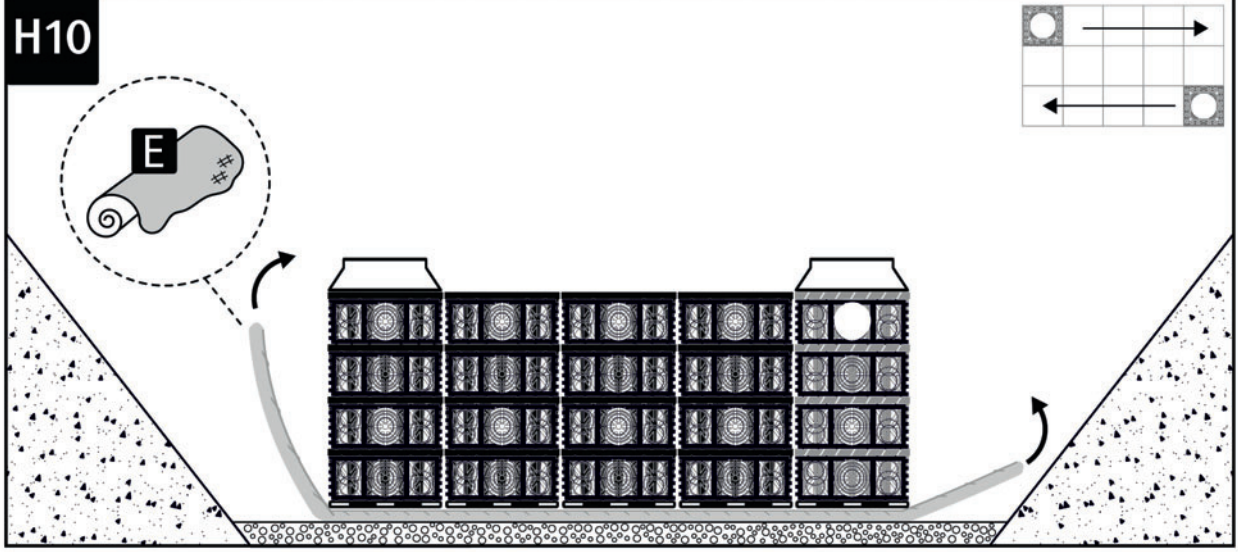

EcoBloc Inspect smart/ smart plus

H11

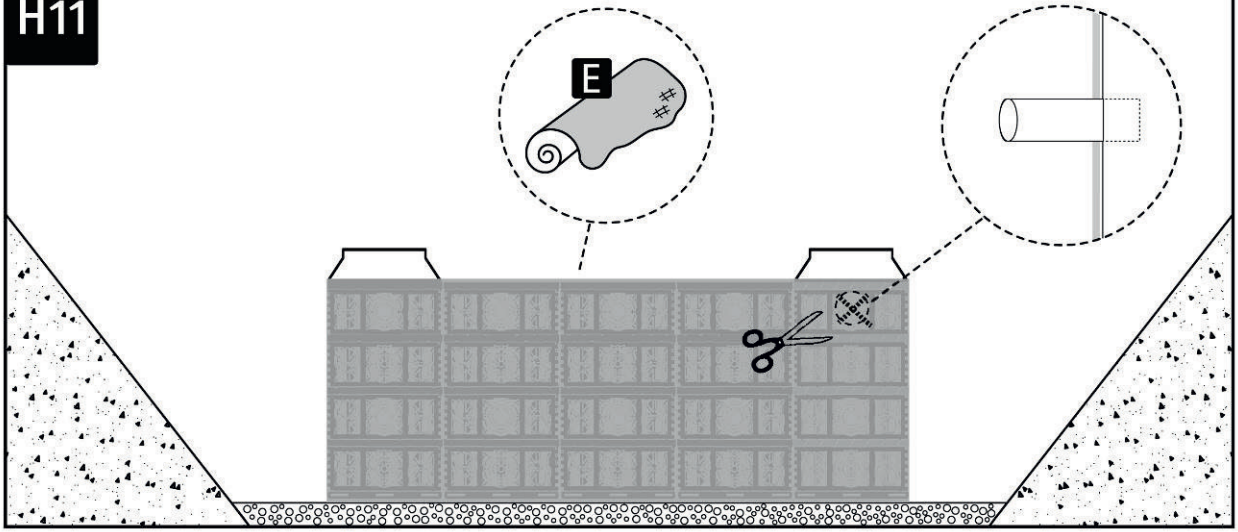

H12

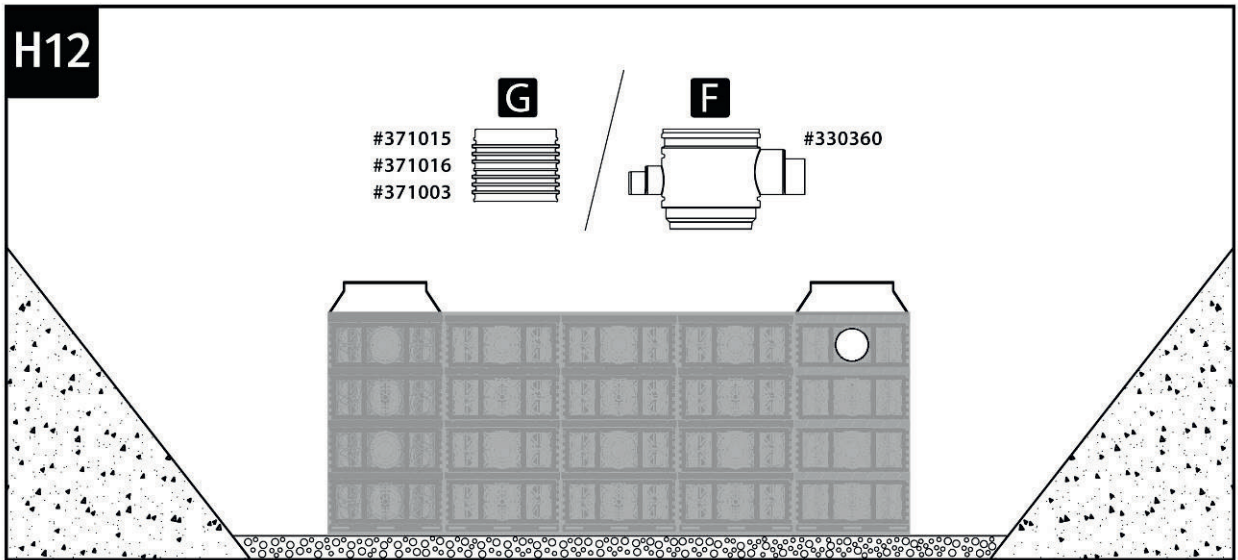

H13

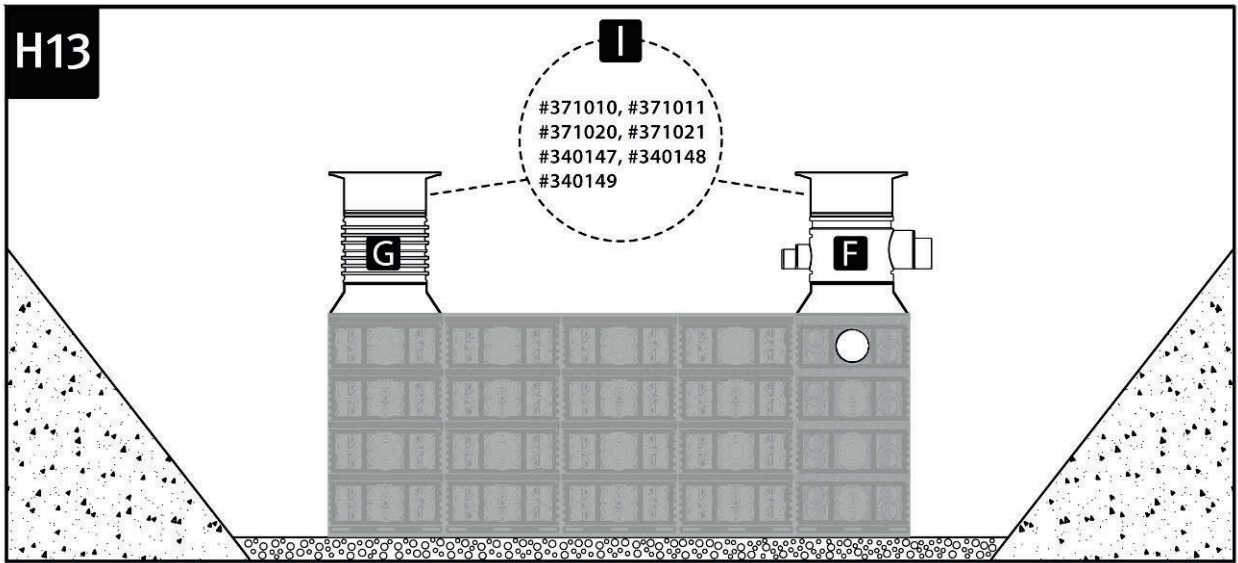

EcoBloc Inspect smart/ smart plus

H14

30 cm 11.8"

30 cm 11.8"

8/16 mm
0.31 - 0.63"

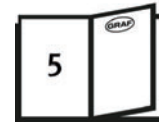
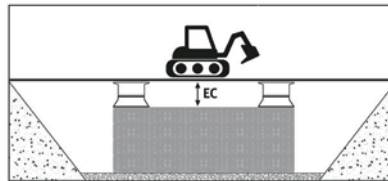
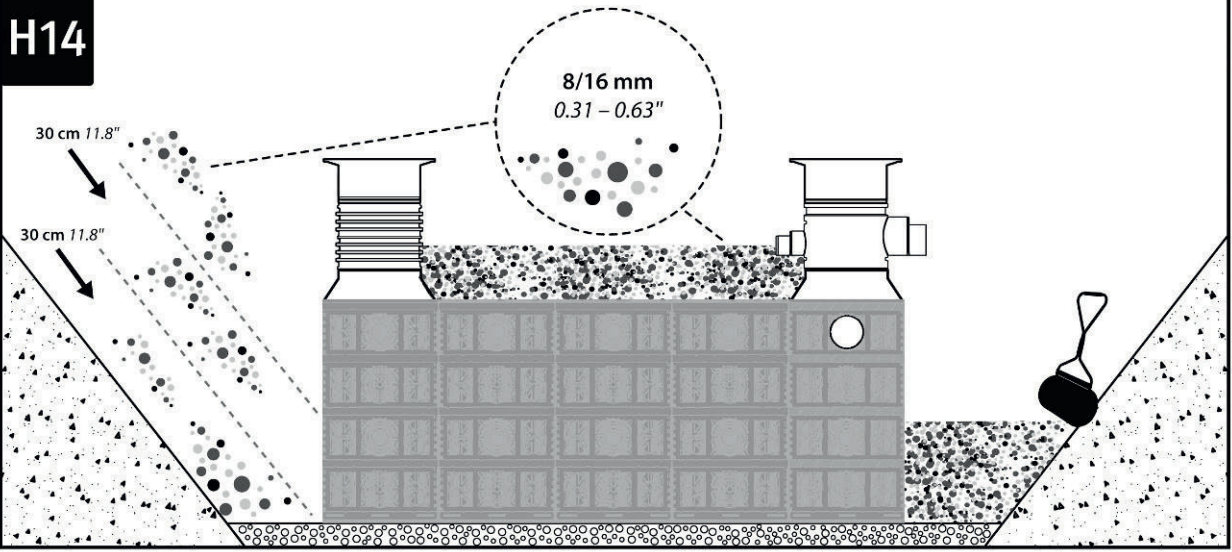

EcoBloc Inspect smart/ smart plus

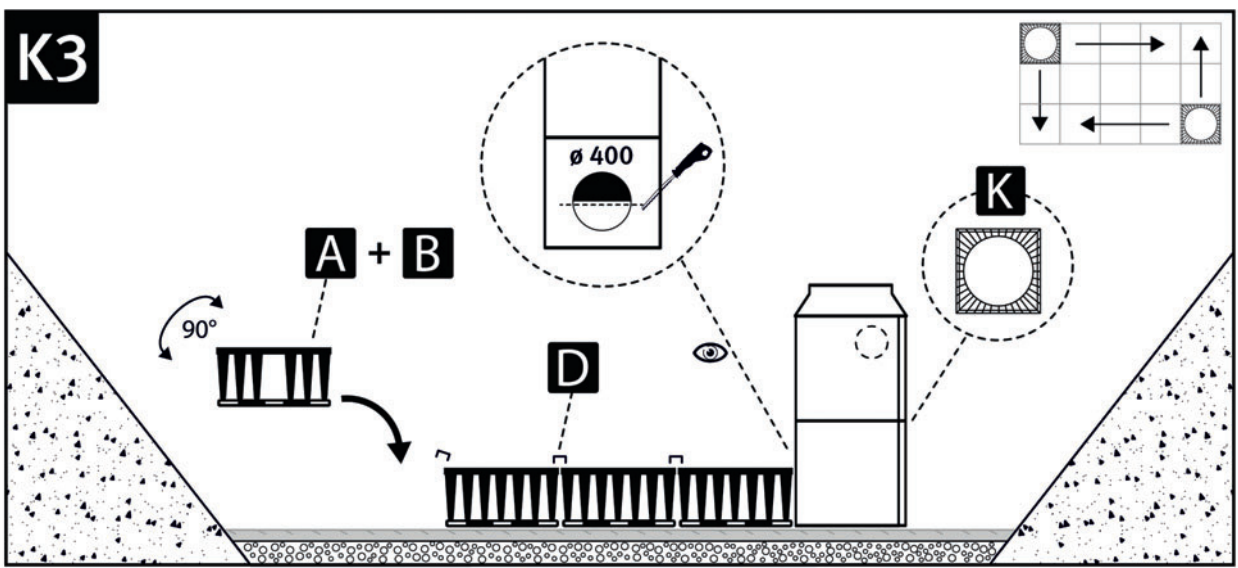
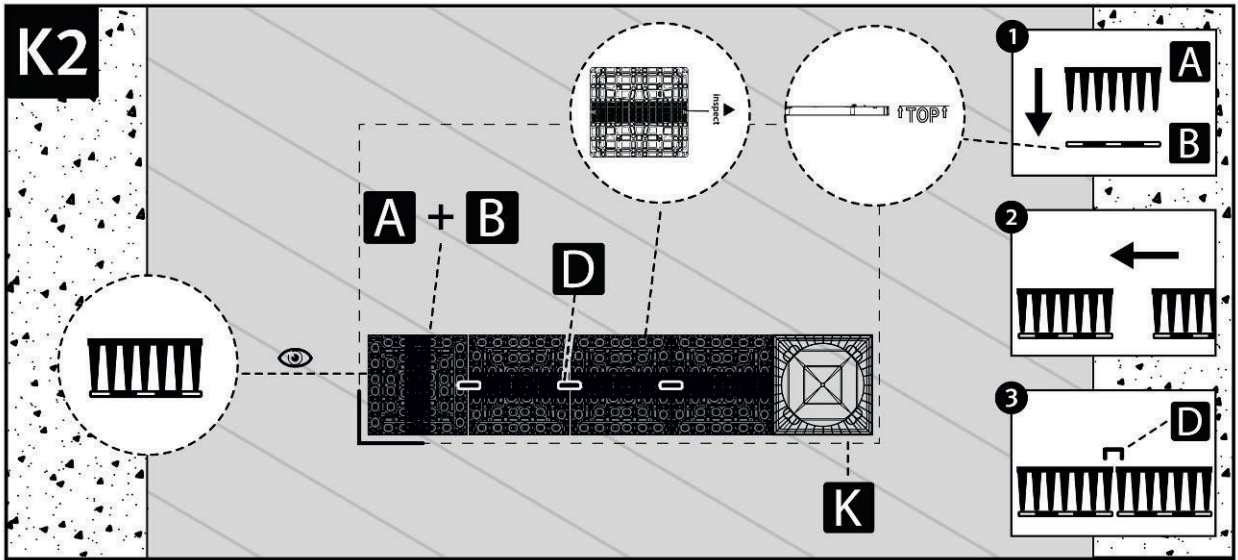
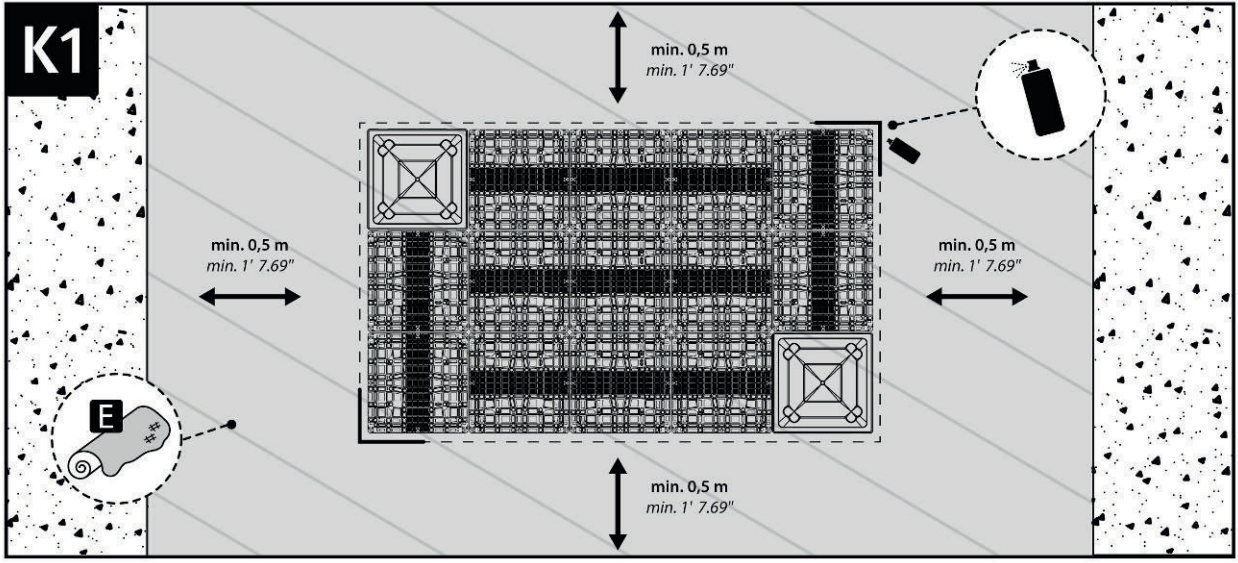

K4

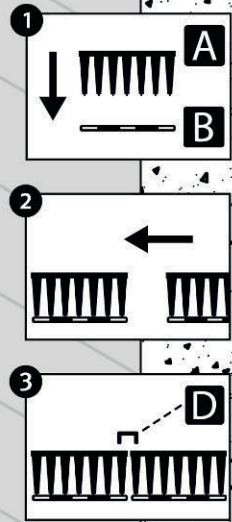
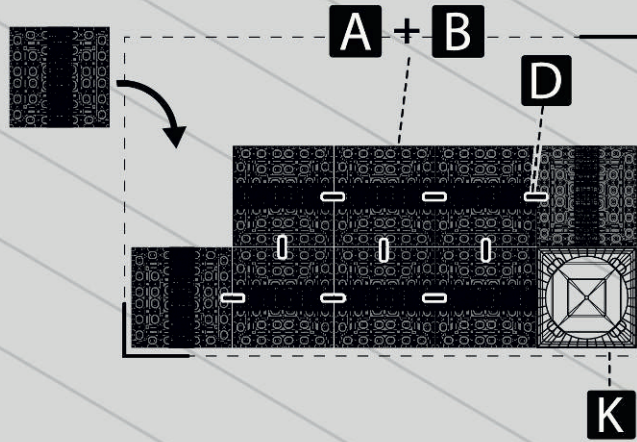

K5

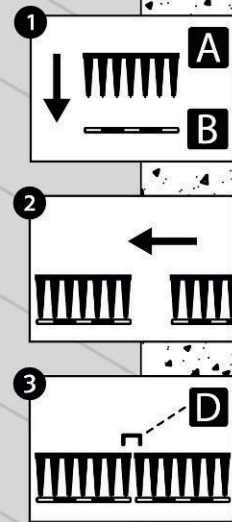
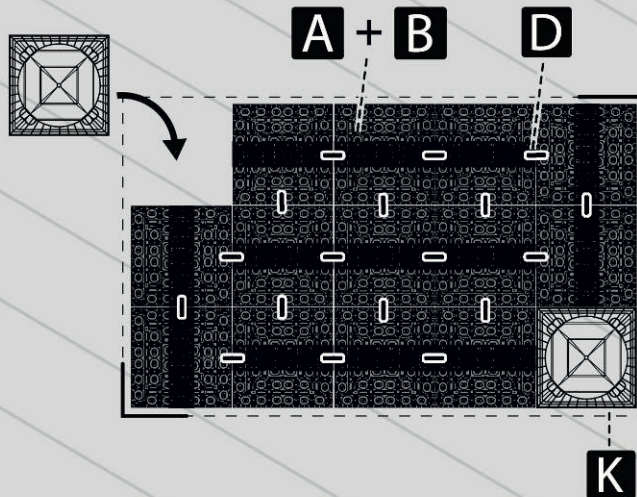

K6

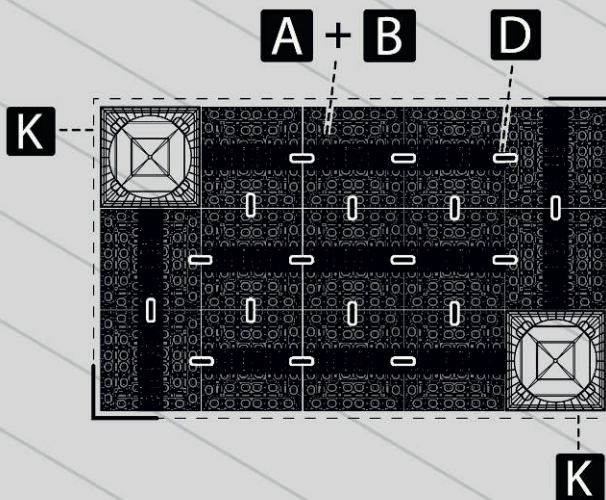

K7

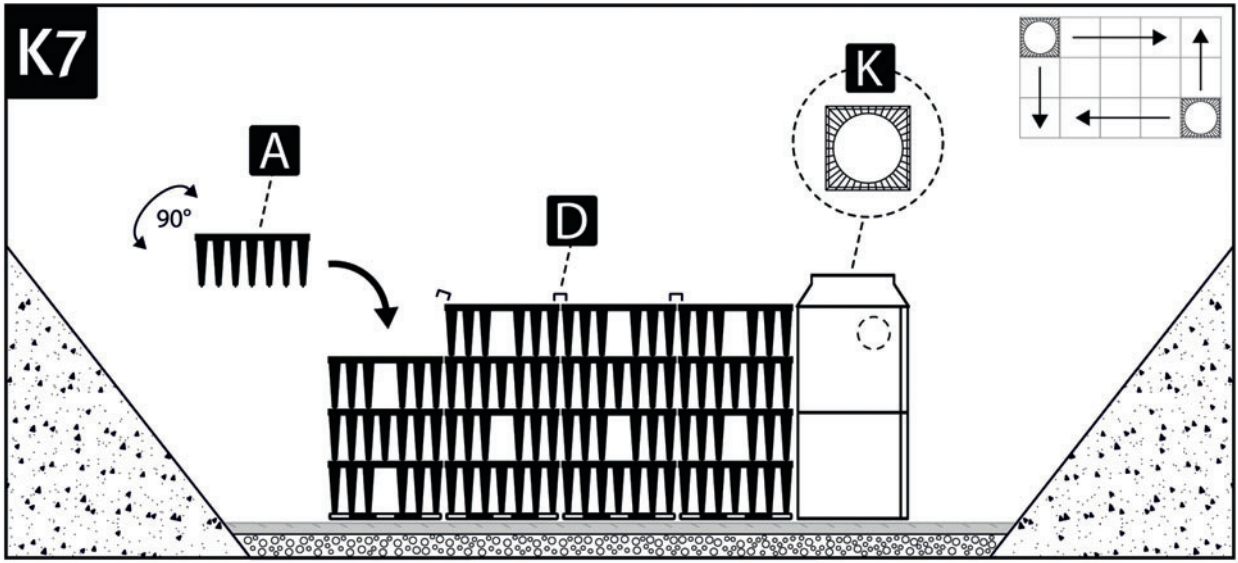

K8

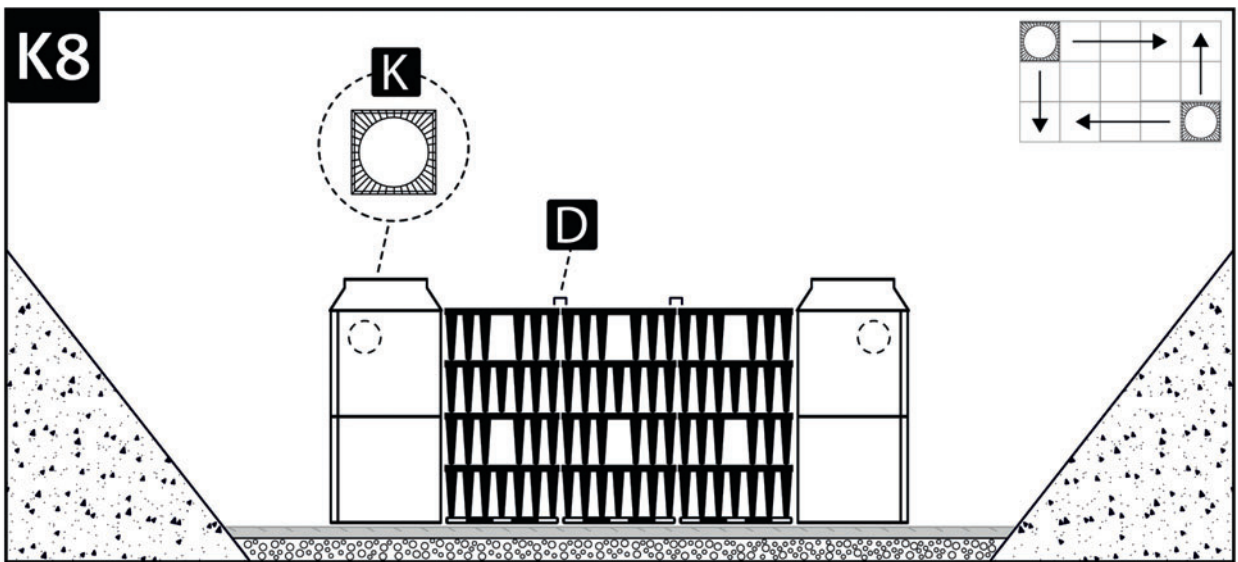

K9

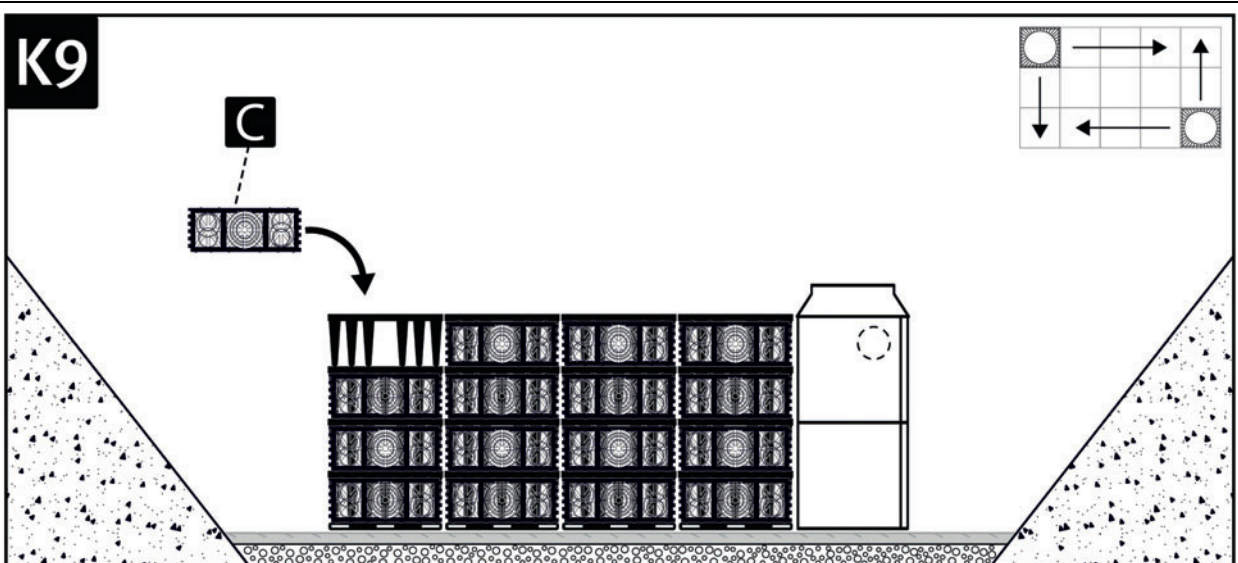

EcoBloc Inspect smart/ smart plus

K10

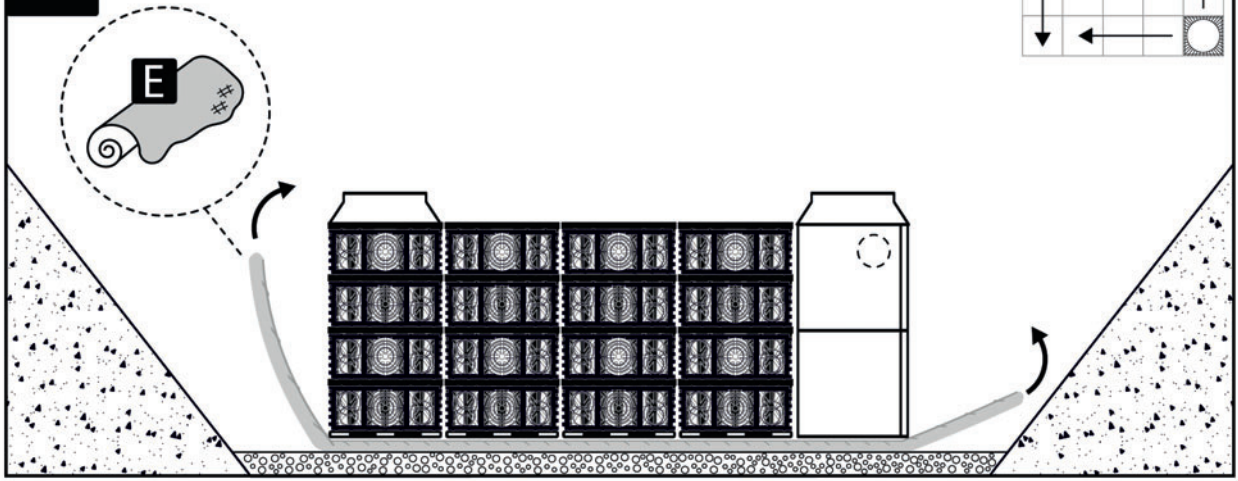

K11

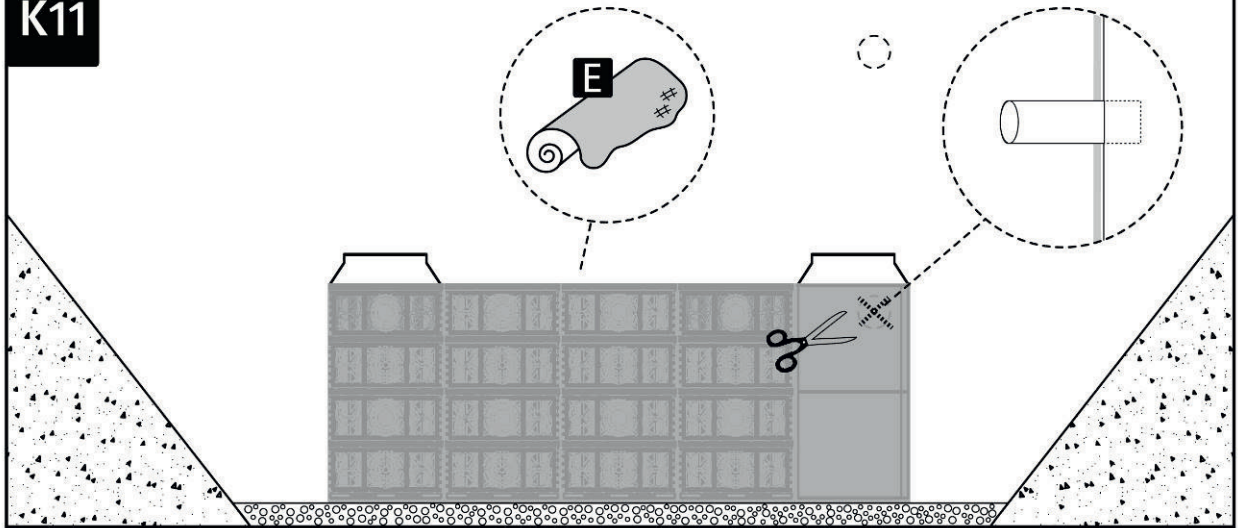

K12

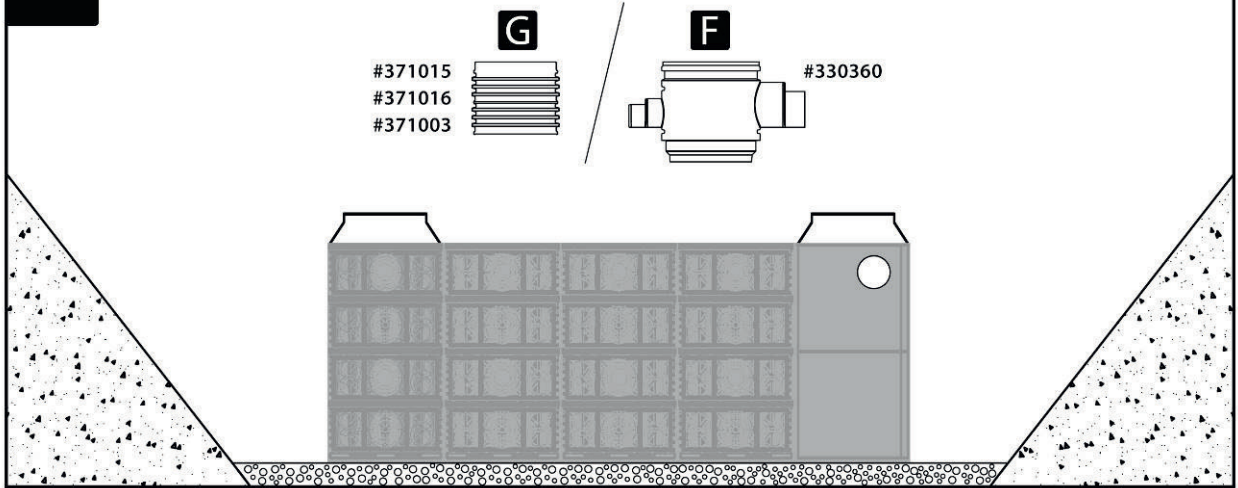

EcoBloc Inspect smart/ smart plus

K13

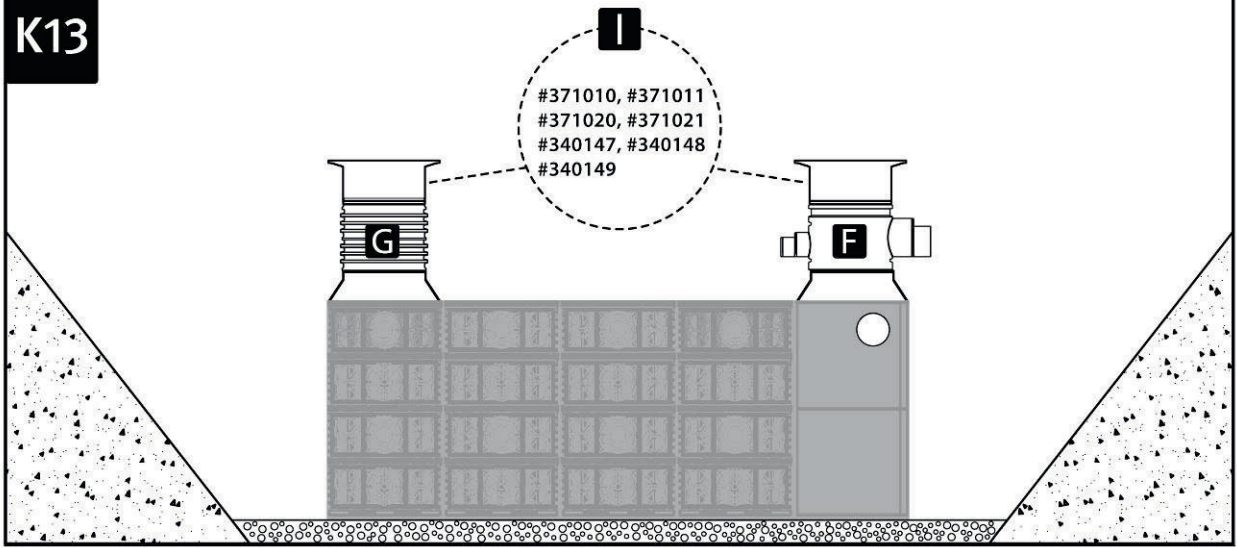

K14

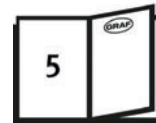
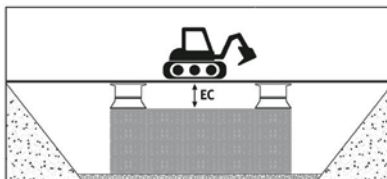
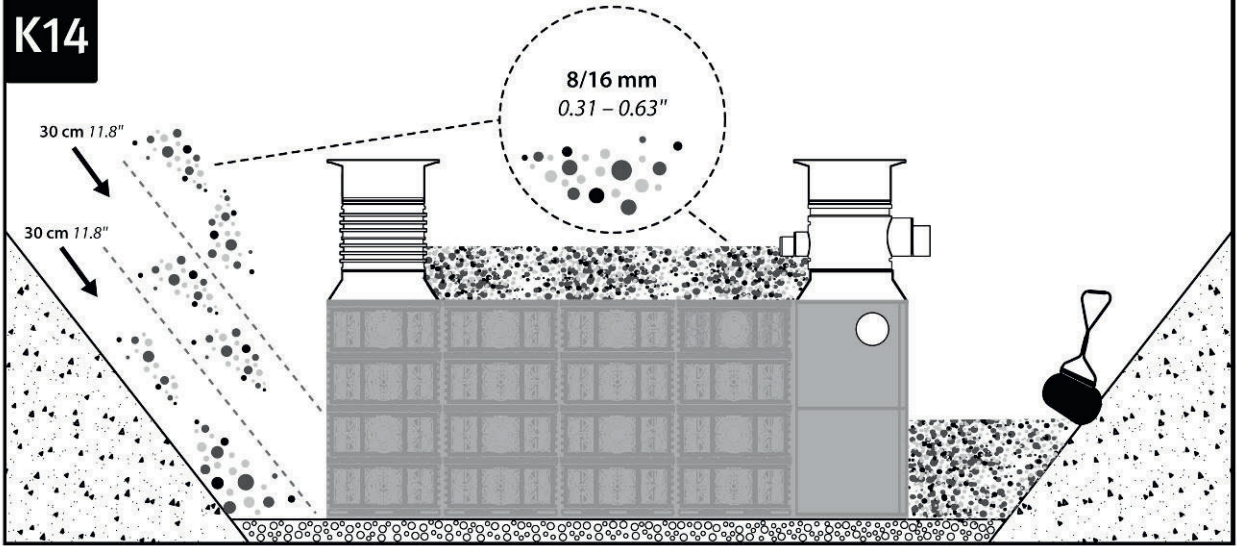

www.graf.info



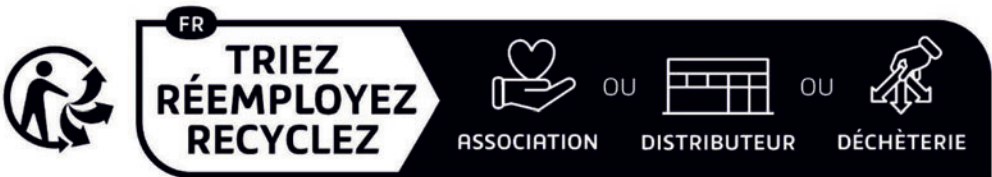
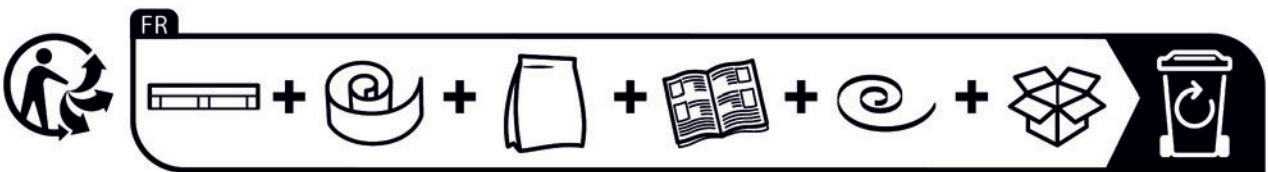

Adresses sur quefairedemesdechets.fr

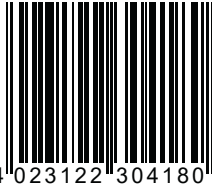

963338