

TANK SIZES & DIMENSIONS

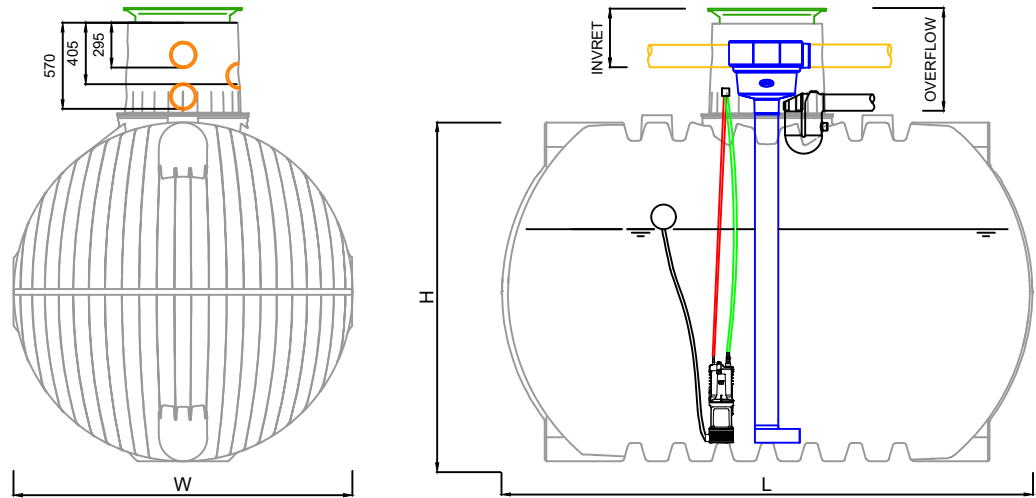

	8,500L	10,000L	13,000L
LENGTH	3,500mm	3,520mm	4,590mm
WIDTH	2,040mm	2,240mm	2,500mm
HEIGHT	2,090mm	2,290mm	2,550mm
INVERT	465-745mm	465-745mm	465-745mm
OVERFLOW	630-910mm	630-910mm	630-910mm

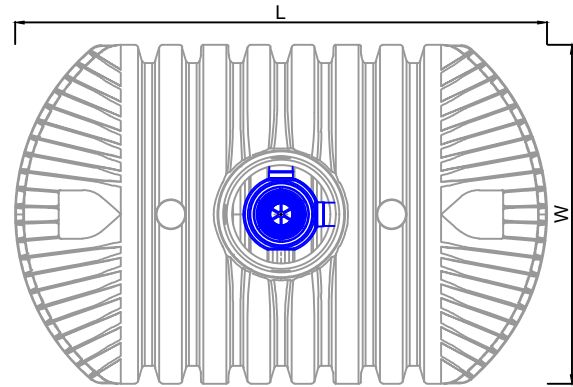



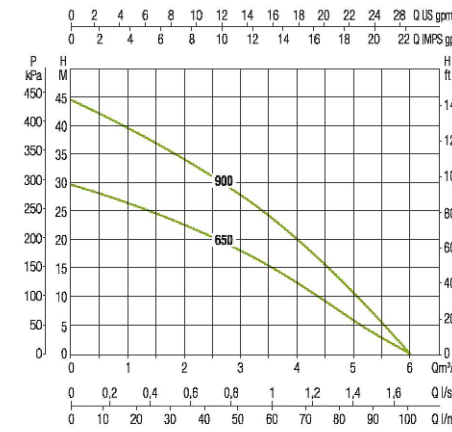
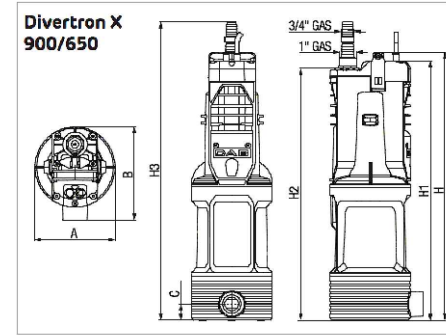

SUBMERSIBLE PUMP DETAILS

DAB DIVERTRON 900X



SYSTEM ACCESSORIES

-  HOSE CONNECTION BOX -EXTERNAL (STANDARD SUPPLY)
-  HOSE CONNECTION BOX - INTERNAL (STANDARD SUPPLY)
-  SPRING WATER SHAFT (OPTIONAL EXTRA)
-  INTERNAL CLEANING UNIT (OPTIONAL EXTRA)
-  DIGITAL FILL LEVEL SENSOR (OPTIONAL EXTRA)

THIS DOCUMENT IS SUPPLIED IN STRICT CONFIDENCE AND MUST NOT BE LENT, REPRODUCED OR DISCLOSED TO ANY THIRD PARTY WITHOUT THE WRITTEN CONSENT OF GRAF UK LIMITED

DO NOT SCALE - IF IN DOUBT ASK

Notice: This drawing is issued only as a guideline and is an estimate of the materials required to construct the drainage system, it should not be used for construction purposes.

Graf UK Ltd makes no warranty or guarantee in relation to the suitability of any of the layout details shown on this drawing in relation to a particular scheme.

NOTES:-

- All dimensions in mm, unless otherwise stated.
- All dimensions are nominal and may vary within manufacturing tolerances.
- All site temporary enabling works by others.
- Graf products to be installed in strict accordance with Graf recommendations.
- This drawing is intended for guidance only. Confirmation of the suitability for a particular project should be sought from the consulting engineers prior to final design or commencement of any construction works.

GARDEN COMFORT CARAT XL SPECIFICATION



TANK ACCESSORIES

Item	Diameter ϕ	Min. Height (mm)	Max. Height (mm)	Max. Loading (kg)*
Pedestrian Loading Lid (Mini)	ϕ 600mm	60mm	360mm	150kg
Pedestrian Loading Lid (Maxi)	ϕ 600mm	60mm	476mm	150kg
Vehicle Loading Lid	ϕ 625mm	60mm	476mm	3,500kg
Extension Sleeve (1m)	ϕ 670mm	500mm	1,000mm	
Extension Sleeve	ϕ 680mm	250mm		
Tank Dome (Maxi)	ϕ 650mm	610mm		

* Loading up to 12,000kg achievable (suitable cover to be provided by others)
 ** Tank Dome (Maxi) available with DN100 or DN150 connections

FILTER DETAILS

UNIVERSAL FILTER 3 XL (INTERNAL)

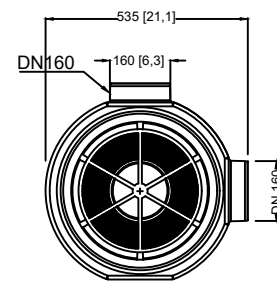
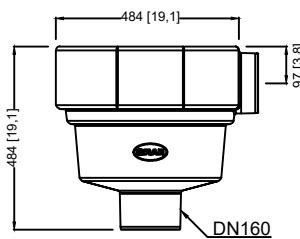
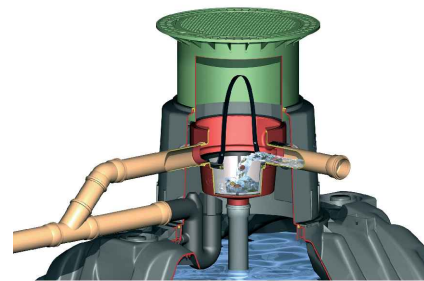

Pedestrian Loading Lid (Mini)

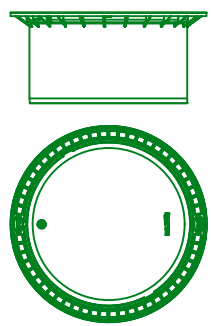

Pedestrian Loading Lid (Maxi)

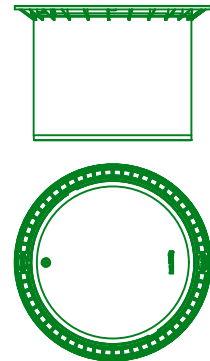

Vehicle Loading Lid

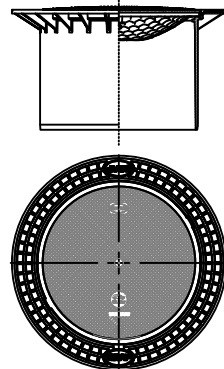

Extension Sleeve (1m)

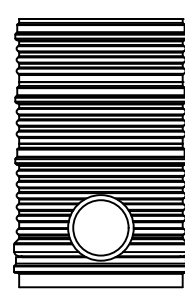

Extension Sleeve

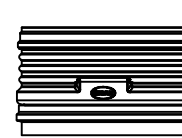

Tank Dome (Maxi)

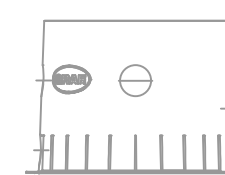

NOTE:- Tank accessory suitability may vary depending on project. Please contact Graf UK for sizing and support.

P0	LATEST REVISION	FC	15.04.24
REV.	DESCRIPTION	BY	DATE



GRAF UK Limited, Regen House, Beaumont Road, Banbury, Oxfordshire, OX16 1RH

T: 01608 661500 F: 01295 211333

E: info@grafuk.co.uk www.grafuk.co.uk

DRAWN : KS	DATE : 15.04.2024
CHECKED : DS	SCALE : VARIOUS@A3

PROJECT	GRAF STANDARD DETAILS
---------	-----------------------

DESCRIPTION	GARDEN COMFORT RAINWATER HARVESTING SYSTEM CARAT XL TANK
-------------	--

DRAWING No.	REV.
GARDEN COMFORT_STANDARD DETAIL_CARAT_XL	P0
	Page.1

SCOPE OF SUPPLY

SUPPLIED BY GRAF:

1. Underground tank
2. Telescopic lid
3. Filter
4. Submersible pump
5. Internal hose connection box
6. External hose connection box

SUPPLIED BY OTHERS:

7. 100mm duct for pump cable
8. 100mm drainage pipe to connect downpipes to inlet (all downpipes to be brought into one single inlet)
9. 100mm pipe for overflow from tank



INTERNAL/EXTERNAL HOSE CONNECTION BOXES

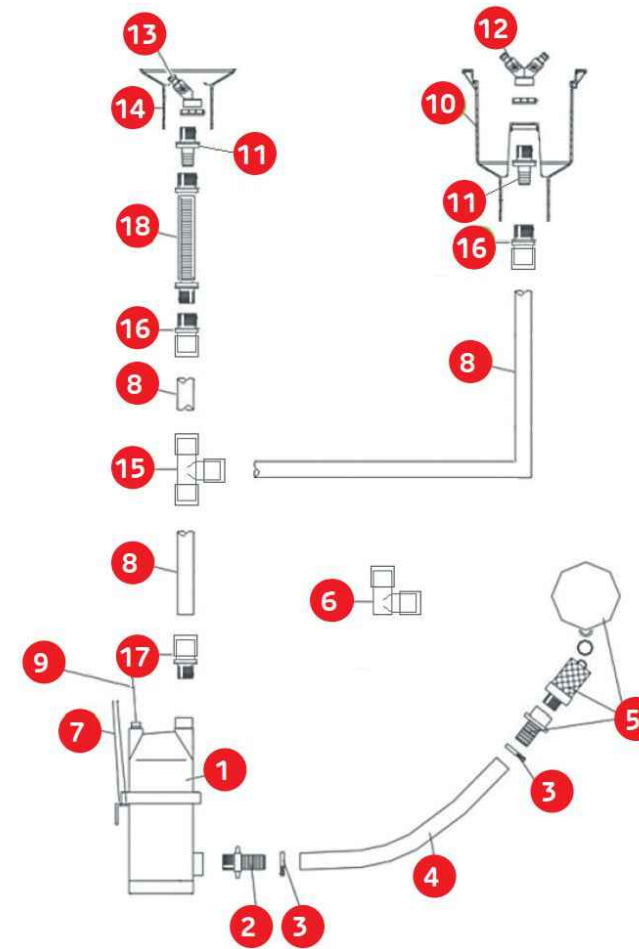

1. Submersible pump
2. Brass hose screwing
3. Hose clip
4. Suction hose
5. Floating suction set
6. 25mm compression elbow (optional fitting used for external tap connection)
7. Fixing set for submersible pump
8. Pressure hose, black & green colour, length 25m
9. Electricity supply, length 10m, 3-core cable
10. External hose connection box
11. 3 / 4 " tank connector
12. 2-way regulating plug
13. Hose-lock connector
14. Internal hose connection box, located on manhole cover of rainwater tank
15. 25mm compression T-fitting
16. 25mm compression x 3 / 4 " female threaded fitting
17. 25mm compression x 1 " male threaded fitting
18. 1m length of braided hose, 3 / 4 " male x 3 / 4 " female connections

NOTE:- Tank accessory suitability may vary depending on project. Please contact Graf UK for sizing and support.

GARDEN COMFORT CARAT XL SCHEMATIC

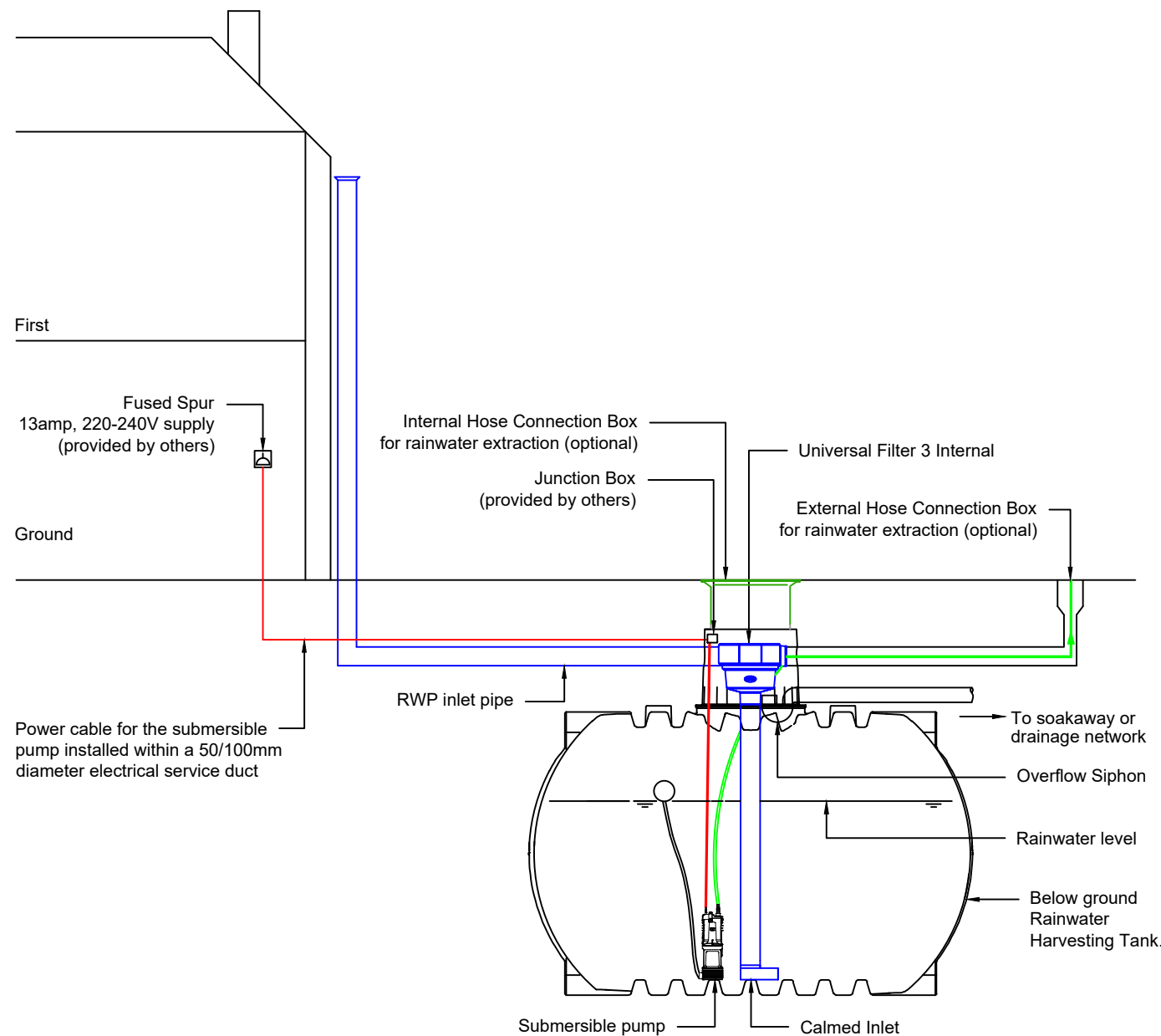

THIS DOCUMENT IS SUPPLIED IN STRICT CONFIDENCE AND MUST NOT BE LENT, REPRODUCED OR DISCLOSED TO ANY THIRD PARTY WITHOUT THE WRITTEN CONSENT OF GRAF UK LIMITED

DO NOT SCALE - IF IN DOUBT ASK

Notice: This drawing is issued only as a guideline and is an estimate of the materials required to construct the drainage system, it should not be used for construction purposes.

Graf UK Ltd makes no warranty or guarantee in relation to the suitability of any of the layout details shown on this drawing in relation to a particular scheme.

NOTES:-

1. All dimensions in mm, unless otherwise stated.
2. All dimensions are nominal and may vary within manufacturing tolerances.
3. All site temporary enabling works by others.
4. Graf products to be installed in strict accordance with Graf recommendations.
5. This drawing is intended for guidance only. Confirmation of the suitability for a particular project should be sought from the consulting engineers prior to final design or commencement of any construction works.

GARDEN COMFORT CARAT XL SCHEMATIC



P0	LATEST REVISION	KS	16.04.24
REV.	DESCRIPTION	BY	DATE



GRAF UK Limited, Regen House, Beaumont Road, Banbury, Oxfordshire, OX16 1RH

T: 01608 661500

F: 01295 211333

E: info@grafuk.co.uk

www.grafuk.co.uk

DRAWN :	KS	DATE :	16.04.2024
CHECKED :	DS	SCALE :	VARIOUS@A3

PROJECT
GRAF STANDARD DETAILS

DESCRIPTION
GARDEN COMFORT RAINWATER HARVESTING SYSTEM CARAT XL TANK

DRAWING No.	REV.
GARDEN COMFORT_STANDARD_DETAIL_CARAT_XL	P0
	Page.2

TRENCH DETAILS

FOR SUFFICIENT WORKING ROOM, THE BASE AREA OF THE TRENCH MUST EXCEED THE DIMENSIONS OF THE TANK BY 500mm ON ALL SIDES.

MINIMUM DISTANCE FROM SOLID STRUCTURES TO BE 1000mm.

THE TRENCH EMBANKMENT MUST BE DESIGNED SO SLIPPAGE OR COLLAPSE OF THE EMBANKMENT WALL IS NOT TO BE ANTICIPATED.

THE CONSTRUCTION SITE MUST BE HORIZONTAL AND PLANE AND MUST GUARANTEE SUFFICIENT LOAD-BEARING CAPACITY.

THE DEPTH OF THE TRENCH MUST BE DIMENSIONED SO THAT THE MAXIMUM COVER ABOVE THE TANK IS NOT EXCEEDED (SEE BELOW DETAILS).

THE TANK AND ANY OTHER COMPONENTS THAT CARRY WATER MUST BE INSTALLED IN A FROST-FREE AREA. THE FROST-FREE DEPTH IS USUALLY APPROX. 600mm-800mm. EXACT DEPTHS CAN BE OBTAINED FROM THE RESPONSIBLY AUTHORITY.

A 150mm-200mm COMPACTED LAYER OF 10-20mm ROUND GRAIN GRAVEL IS INSTALLED AT THE BASE OF THE EXCAVATION.

MINIMUM & MAXIMUM COVER

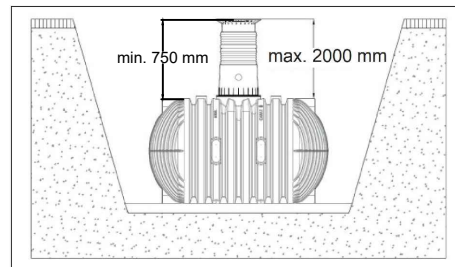

MINIMUM COVER IN A LANDSCAPED AREA TO BE 750mm FROM SHOULDER OF TANK.

MAXIMUM COVER IN A LANDSCAPED AREA TO BE 2000mm FROM SHOULDER OF TANK.

SLOPE/EMBANKMENT INSTALLATIONS

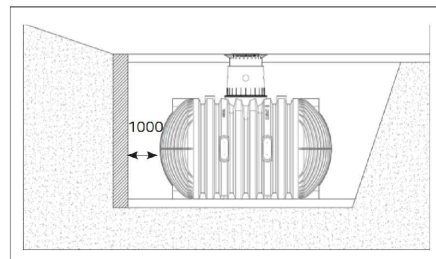

IF THE TANK IS TO BE INSTALLED IN THE IMMEDIATE VICINITY (<5m) OF A SLOPE OR EMBANKMENT, A STATICALLY CALCULATED RETAINING WALL MUST BE ERECTED TO ABSORB ANY ADDITIONAL LOADING FROM THE SOIL. THE WALL MUST EXCEED THE DIMENSIONS OF THE TANK BY AT LEAST 500mm IN ALL DIRECTIONS AND MUST BE LOCATED AT LEAST 1000mm AWAY FROM THE TANK.

GROUNDWATER INSTALLATIONS

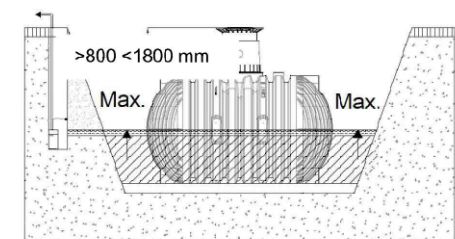

TO MAINTAIN THE DESIRED TANK DEPTH, ENSURE PROPER DRAINAGE IS APPLIED IN AREAS WITH GROUND WATER AND IMPERMEABLE SOIL. USING A DRAINAGE LINE ENDING IN WITH A CHAMBER AND AN IMMERSION PUMP TO PUMP EXCESS WATER AWAY FROM THE SITE. REGULARLY INSPECT THE PUMP FOR OPTIMAL FUNCTIONALITY. IF IT IS EXPECTED THAT THE TANK MAY SINK LOWER, ADEQUATE DRAINAGE MUST BE ENSURED.

TANK SIZE	8,500L	10,000L	13,000L
IMMERSION DEPTH	1042.50mm	1142.50mm	1232.50mm

MINIMUM COVER TO BE 800mm FROM SHOULDER OF TANK IN AREAS WITH GROUNDWATER.

MAXIMUM COVER TO BE 1800mm FROM SHOULDER OF TANK IN AREAS WITH GROUNDWATER.

INSERTION & FILLING

THE TANK MUST BE INSERTED, IMPACT-FREE, INTO THE PREPARED TRENCH USING SUITABLE EQUIPMENT.

THE TANK IS FILLED WITH 25cm WATER BEFORE BACKFILLING. THE 10-20mm ROUND GRAIN GRAVEL IS BACKFILLED IN LAYERS OF MAX. 400mm STEPS AND IS TO BE WELL COMPACTED WITH A MANUAL TAMPER. MECHANICAL COMPACTON MACHINES ARE NOT TO BE USED UNDER ANY CIRCUMSTANCES. SURROUND MUST BE AT LEAST 500mm ON ALL SIDES OF THE TANK.

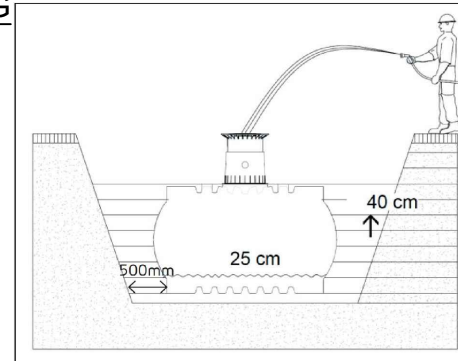

VEHICLE LOADING CONDITIONS

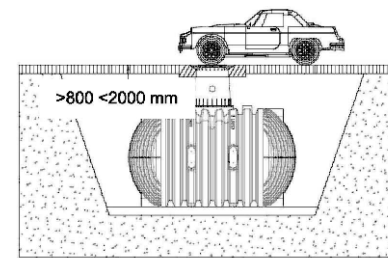

FOR LOADINGS OF UP TO 3,500KG IN TRAFFICKED AREAS WITH NO GROUNDWATER, THERE MUST BE;

MINIMUM COVER OF 800mm FROM THE SHOULDER OF THE TANK, AND

MAXIMUM COVER OF 2000mm FROM THE SHOULDER OF THE TANK.

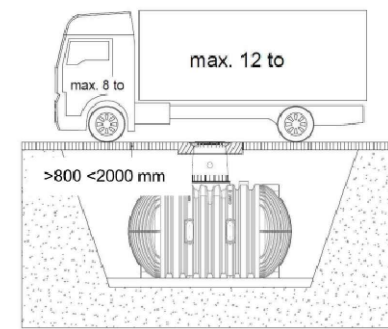

FOR LOADINGS OF MORE THAN 3,500KG AND UP TO 12,000KG IN AREAS OF NO GROUNDWATER, THERE MUST BE;

MINIMUM COVER OF 800mm FROM THE SHOULDER OF THE TANK,

MAXIMUM COVER OF 2000mm FROM THE SHOULDER OF THE TANK, AND

SUITABLE MANHOLE COVER & FRAME (PROVIDED BY OTHERS).

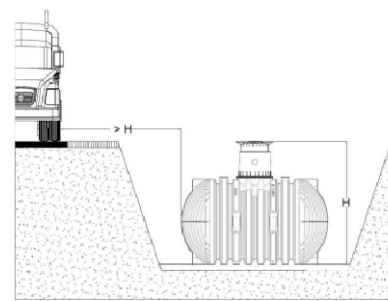

FOR INSTALLATIONS ADJACENT TO SURFACES USED BY VEHICLES OF OVER 3,500KG, THE TANK MUST BE INSTALLED AT A DISTANCE FROM THE ROAD SURFACE THAT IT AT LEAST THE DEPTH OF THE TRENCH.

PIPE CONNECTIONS

ALL PIPE CONNECTIONS MUST BE INSTALLED WITH A FALL OF AT LEAST 1% IN THE DIRECTION OF FLOW (POSSIBLE, SUBSEQUENT SETTLING MUST BE TAKEN INTO ACCOUNT).

IF THE TANK OVERFLOW IS CONNECTED TO A PUBLIC SEWER, THIS MUST BE PROTECTED AGAINST REFLUX BY MEANS OF A LIFTING STATION OR REFLUX SEAL IN ACCORDANCE WITH DIN 1986.

ALL SUCTION, PRESSURE & CONTROL LINES MUST BE INSTALLED IN AN EMPTY PIPE / DUCT AND AS STRAIGHT AS POSSIBLE. ANY NECESSARY BENDS MUST BE FORMED IN 30 DEGREE MOULDED SECTIONS.

IMPORTANT: THE EMPTY PIPE / DUCT MUST BE CONNECTED TO AN APERTURE ABOVE THE MAX. WATER LEVEL.

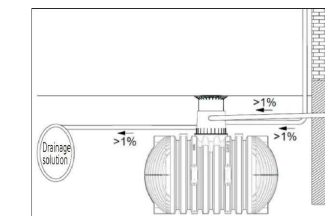

THIS DOCUMENT IS SUPPLIED IN STRICT CONFIDENCE AND MUST NOT BE LENT, REPRODUCED OR DISCLOSED TO ANY THIRD PARTY WITHOUT THE WRITTEN CONSENT OF GRAF UK LIMITED

DO NOT SCALE - IF IN DOUBT ASK

Notice: This drawing is issued only as a guideline and is an estimate of the materials required to construct the drainage system, it should not be used for construction purposes.

Graf UK Ltd makes no warranty or guarantee in relation to the suitability of any of the layout details shown on this drawing in relation to a particular scheme.

NOTES:-

- All dimensions in mm, unless otherwise stated.
- All dimensions are nominal and may vary within manufacturing tolerances.
- All site temporary enabling works by others.
- Graf products to be installed in strict accordance with Graf recommendations.
- This drawing is intended for guidance only. Confirmation of the suitability for a particular project should be sought from the consulting engineers prior to final design or commencement of any construction works.

GARDEN COMFORT CARAT XL TANK INSTALLATION



P0 LATEST REVISION KS 31.05.2024

REV. DESCRIPTION BY DATE

GRAF GRAF UK Limited
GRAF UK Limited, Regen House, Beaumont Road, Banbury, Oxfordshire, OX16 1RH

T: 01608 661500 F: 01295 211333
E: info@grafuk.co.uk www.grafuk.co.uk

DRAWN : KS DATE : 14.06.2023
CHECKED : DS SCALE : VARIOUS@A3

PROJECT
GRAF STANDARD DETAILS

DESCRIPTION
GARDEN COMFORT RAINWATER HARVESTING SYSTEM CARAT XL TANK

DRAWING No. REV.
GARDEN_COMFORT_STANDARD_DETAIL_CARAT_XL P0
Page.3

PLEASE REFER TO TANK INSTALLATION GUIDE FOR DETAILS ON; SAFETY, PRODUCT FEATURES, IDENTIFICATION OBLIGATIONS, TECHNICAL DATA, TANK STRUCTURE, TANK ASSEMBLY & SERVICING AND INSPECTION.